

WRIGHT-AUSTIN



STEAM SAVING EQUIPMENT



CATALOG NO. 33

WRIGHT-AUSTIN CO.

Engine Division Office
30 Church St., NEW YORK, N. Y.
Phone Concord 3807

WRIGHT-AUSTIN

Steam Saving Equipment



CATALOG NO. 33

Main Office

Wright-Austin Company

315 West Woodbridge Street, Detroit, Mich.

NEW YORK BRANCH OFFICE
30 Church St., New York, N. Y.

CABLE ADDRESS W. U. CODE
Riteaustin, New York

MANUFACTURERS OF

Steam, Oil and Air Separators
Exhaust Heads

Steam, Grease and Air Traps
Strainers

Alarm Water Columns

Water Gauges

Try-Cocks

Automatic Feed Water Regulators

Gauge Glass Protectors

Pump Governors

Agents and Jobbers in Principal Centers

From One Engineer to Another

We, who are engaged in the business of engineering, keenly appreciate the problems that those in charge of the construction or operation of power plants have to contend with. We feel that the Engineer has an extra measure of problems to solve—more than falls to the lot of other professions.

One reason for this appreciation is that most of the men in our organization have been "through the mill" themselves. Some of them have had years of practical experience in power plant and process steam work. We know that the position which an Engineer holds, as well as his success, depends upon his judgment in selecting equipment for a plant or the degree of efficiency at which he is able to make it operate.

In presenting the Wright-Austin "RED BOOK" for the fourth time to the profession we hope we have made a real contribution toward solving a number of the problems which arise in power plant and process steam work. The equipment that is listed in this catalog is "time tested" and has been thoroughly proved during 35 years of successful manufacturing.

To Engineers throughout the United States and a considerable number of foreign countries, the name "WRIGHT-AUSTIN" stands for dependability and satisfaction. Every piece of Wright-Austin equipment is a reflection of the years of concentrated experience this Company has had in manufacturing a limited line of Steam Saving Equipment.

In this "RED BOOK" are illustrated, first, the well tried and carefully perfected stock patterns of Separators, Exhaust Heads, Traps and Water Columns which have made the WRIGHT-AUSTIN name a byword for quality and service; second, patterns of especially constructed Separators which can be built to customer's requirements on short notice at moderate prices; third, several well tested entirely new improvements on trycocks, water gauges, and gauge glass protectors; fourth, the new and modern "Airxpel" Steam Trap. Particular emphasis is placed on this third and fourth classes of equipment because it will be the important apparatus of the future, and because the Wright-Austin Company is exceptionally well equipped to manufacture it.

The names "Wright," "Austin," and "Murray" have been superseded by the name "WRIGHT-AUSTIN" throughout the catalog.

We are glad at any time to handle any inquiry or order, whether large or small. A large stock is carried in Detroit at all times and is ready for immediate shipment.

THE WRIGHT-AUSTIN ENGINEERS

SECTION I

Steam Separators Oil Separators Air Separators Exhaust Heads

BULLETIN No. 303

PAGE NUMBERS, mentioned in the text of this catalog, apply to the Section or Bulletin in which the references occur.

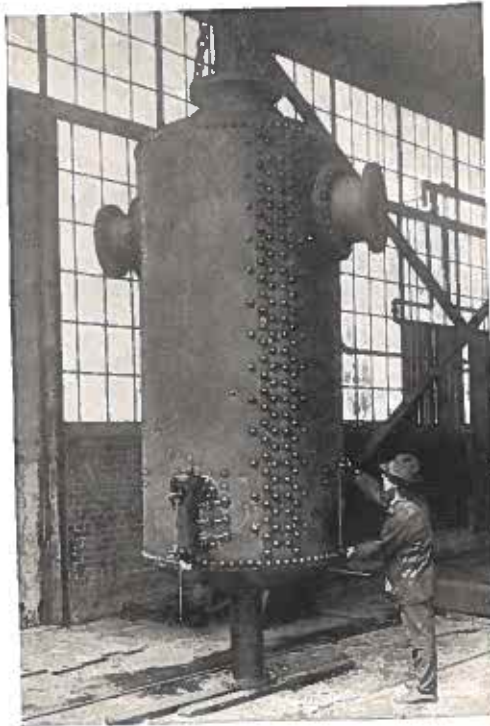
Wright-Austin Separators**"Standard Special" Separator**

With alarm water column instead of water gauge—built to serve three engines.

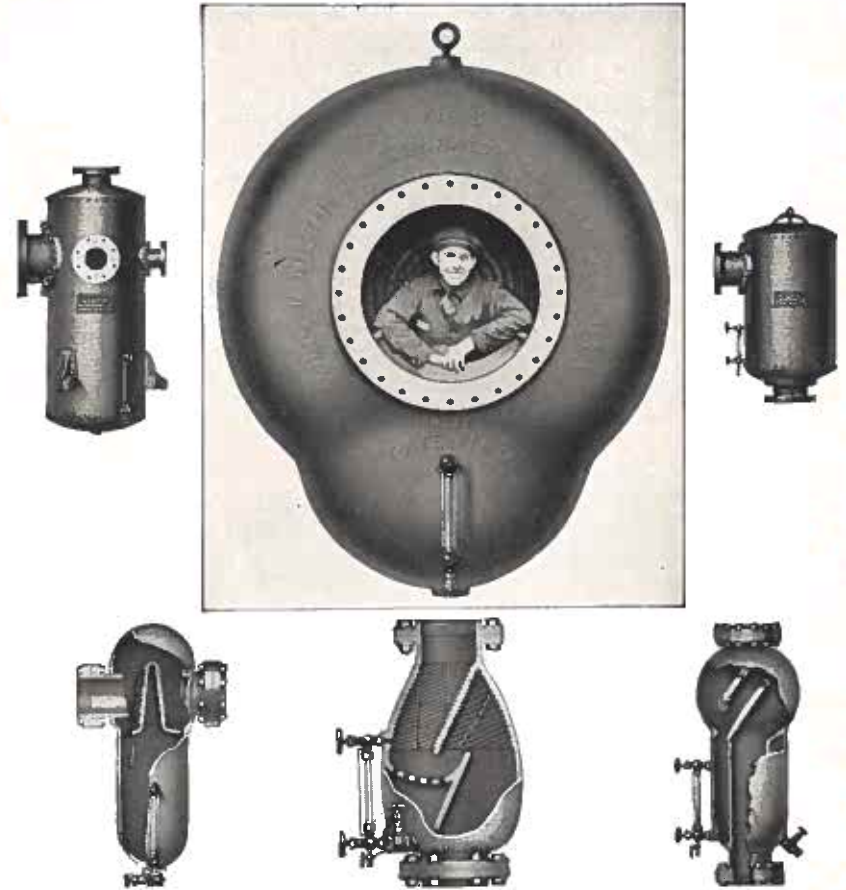
**A Few Wright-Austin Types**

THE WRIGHT-AUSTIN LINE COMPRISES THE LARGEST NUMBER OF TYPES AND SIZES OF SEPARATORS MADE BY ONE MANUFACTURER IN THE WORLD

The Wright-Austin Company now makes seventeen regular types of Separators, besides special Separators of every description. Twelve of the regular types are Steam Separators, three types are Oil Separators, two types are Air and Gas Separators. The average number of sizes per type is twelve and a majority of all sizes of all regular types is carried in Detroit Stock. Sixteen of the many special styles are illustrated in this bulletin making a total of 33 types shown.

It is an immense advantage to an engineer or power plant operator to have such a large line to choose from.

CHOOSE A SEPARATOR TO SUIT YOUR CONDITIONS

In making a selection from so wide a variety of vertical, horizontal, angle and special patterns and sizes, all the advantages of the finer features of efficient separation are more easily obtained by:

- 1—The correct Separator for your every-day operating conditions—thus insuring the highest efficiency obtainable.
- 2—The most suitable Separator for your piping arrangement—this often greatly reduces the cost of installation by avoiding added expense for pipe and fitting changes. In most cases the price of the Separator will be more than repaid by the saving in piping.

When there are only a small number of types to choose from, a customer frequently has to accept a type of Separator which does not meet the conditions perfectly. He is then obliged to adopt some makeshift in order to try to meet the situation. **THESE DIFFICULTIES DO NOT OCCUR WITH WRIGHT-AUSTIN SEPARATORS.**

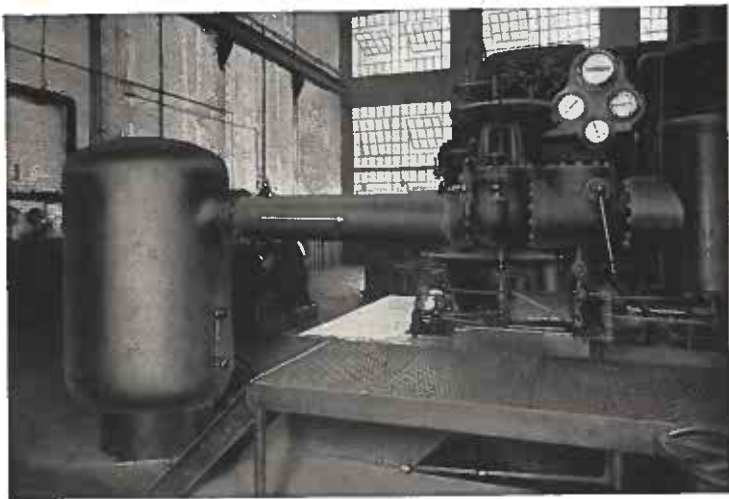

Typical Installation of Riveted Steel Separator Ahead of a Steam Turbine

THIRTY-FIVE YEARS EXPERIENCE MANUFACTURING SEPARATORS AS A PRINCIPAL LINE

“Excellence is no accident” and for thirty-five years the best brains of the Wright-Austin Company have been devoted to the manufacture of Separators of recognized efficiency. There are very few principles of separation or types of Separators which the Wright-Austin Company has not experimented with in these thirty-five years. Where its apparatus is different from that of other manufacturers, investigation has approved the Wright-Austin design.

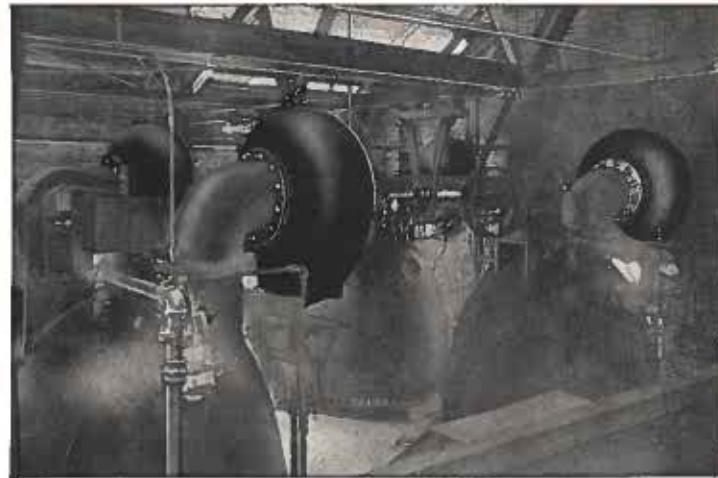

Four of the Ten Horizontal Oil Separators on Evaporators at a Large Chemical Plant

QUALITY

Wright-Austin quality is the result of first-class workmanship, the best material obtainable and designs which have been developed by thirty-five years of experience concentrated upon a few lines of Steam Specialties. Wright-Austin Engineering Service maintains that quality as long as the apparatus is in use.

The splendid reputation which Wright-Austin equipment has had for many years throughout the United States is due to this high quality.

THEORY AND PRACTICE OF SEPARATION

The general theory of separation of moisture, oil or other matter from flowing steam, air or gas, which is confirmed by practical experience, is the same for all gases or vapors, although apparatus for successfully applying the theory varies with the conditions.

If moving steam, air or other gas, carrying particles of condensed vapor, or foreign matter, is directed in a straight stream against a baffle, so that its flow is suddenly diverted, the moving steam or gas, being much lighter than the condensation, will flow around the baffle easily, but the heavier particles of moisture and foreign matter, striking the baffle forcibly, will be stopped and will fall by gravity out of the path of the steam or gas. **THERE IS NO OTHER WAY OF SEPARATING LIQUIDS OR SOLIDS FROM STEAM OR GAS WHICH IS AS COMPLETELY EFFECTIVE AS THIS**, notwithstanding hundreds of attempts which have been made to find other methods.

Of course, Separators must be properly proportioned to get completely satisfactory results, even when the right principle is used. Wright-Austin Sepa-

rators are correctly designed. Thirty-five years of satisfactory service is the best proof of that fact.

The baffle must be of sufficient size and area to collect and carry away all the moisture, oil or solid matter, in such a manner that it cannot again be picked up by the moving steam or gas. The whole Separator must, therefore, be large enough to allow for proper baffle area and in addition must have room to accommodate the sudden change of direction of the steam or gas, without causing friction loss or back pressure. When the Separator is properly designed, this results in a very substantial area at right angles to the flow of the steam or gas.

A Separator is purchased but once in the lifetime of the unit which it serves. There is no upkeep. The first cost is the last cost, but all the time the Separator goes on paying for itself over and over again in the waste eliminated, plus the increased efficiency of the unit protected.

Wright-Austin Separators represent the most up-to-date ideas, practice and improvements. They are designed with ample material for a large factor of safety and before leaving the factory every Separator is carefully inspected and tested.



Six Type "E" Horizontal Live Steam Separators in Cleveland City Water Works, Cleveland, Ohio

WRIGHT-AUSTIN STANDARD TYPES

Steam Separators for Ordinary Conditions. See Page 8

These are Vertical, Horizontal or Angle Types made of cast semi-steel or riveted steel, for saturated steam, built to A. S. M. E. Standard or Extra Heavy Schedule. Ordinarily the cast types can be shipped from Detroit Stock and the riveted steel types within three to five weeks from receipt of order.

Steam Separators for Superheated Steam. See Page 8

These have the same dimensions as the "Steam Separators for Ordinary Conditions," but they are made either of cast steel or of riveted steel, with seamless forged steel or cast steel nozzles. They are not carried in stock but can be furnished in from three to six weeks from receipt of order.

Oil Separators. See Page 28

These are Horizontal, Vertical or Angle Separators made of cast semi-steel, riveted or welded steel, built to A. S. M. E. Standard Schedule, for pressures from 0 lbs. to 50 lbs. per square inch. The Type "V" is a Horizontal Separator intended for vacuum service, that is for pressures below atmospheric. Ordinarily the Type "S" and Type "R" Oil Separators can be shipped from Detroit Stock and other types within three to five weeks from receipt of order.

Riveted Steel Receiver Separators. See Pages 22 and 36

These are all built and tested to the rigid requirements of the A. S. M. E. Boiler Code, whether they are for saturated steam, superheated steam, oil, gas or air; whether they are standard or special. They are not carried in stock but can be shipped within three to six weeks from receipt of order.

Catch-alls. See Pages 29 and 34

Catch-alls for sugar and chemical evaporators, whether condensing or non-condensing, usually require riveted steel construction to meet the local conditions. However, the Type "S" and Type "V" Separators give excellent service where it is possible to install a cast-in-one-piece type of Separator.

Compressed Air Separators. See Page 38

Two Horizontal Types of Separators are available for eliminating oil and moisture from compressed air. Both are made of cast semi-steel. One type is suitable for pressures below 50 lbs., the other is suitable for 50 lbs. to 250 lbs. Ordinarily these can be shipped from Detroit Stock.

Gas Separators. See Page 36

The Wright-Austin Company is constantly furnishing Separators for eliminating oil and moisture from gas or eliminating condensed gas from vaporized gas, but conditions for such service are so variable that these must be known before a type can be recommended.

WRIGHT-AUSTIN GUARANTEE

Every Wright-Austin product is guaranteed against defective material and workmanship for one year from date of shipment.

We also guarantee the efficiency of our Separators as stated by us at time of sale; when installed, drained and operated under the conditions represented to us.

However, the best guarantee we can make is 35 years of unremitting service and integrity to thousands of good customers here, and in many foreign lands.

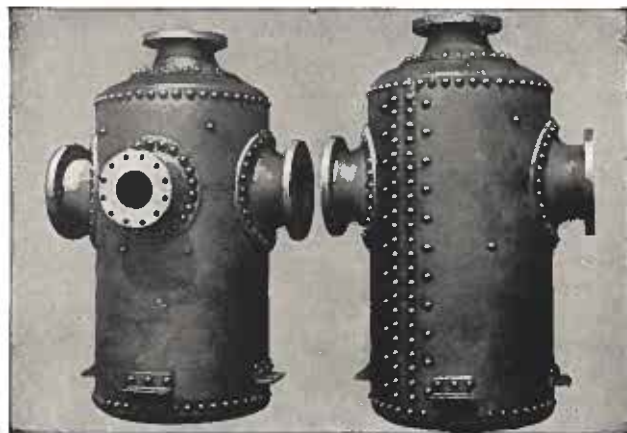

“Standard Special” Steam Separators for 200 Lbs. Pressure, 100° F. Superheat

“STANDARD SPECIAL” TYPES

The Wright-Austin Company is particularly well equipped to build Riveted or Welded Steel Receiver Separators of special design at MODERATE PRICES. The majority of such Separators may be called “Standard Specials” because the principles of their design are standard, although they are special as to dimensions and do not follow this catalogue. There is also much work in connection with them which has been standardized, so that it does not have to be repeated afresh for every Special Separator.

These “Standard Special” Separators can be furnished with semi-steel, forged steel or cast steel nozzles to fit every requirement and to suit any volume, pressure or degree of superheat.

For a complete discussion of this branch of Separator building, one in which the Wright-Austin Company stands pre-eminent, refer to page 22.

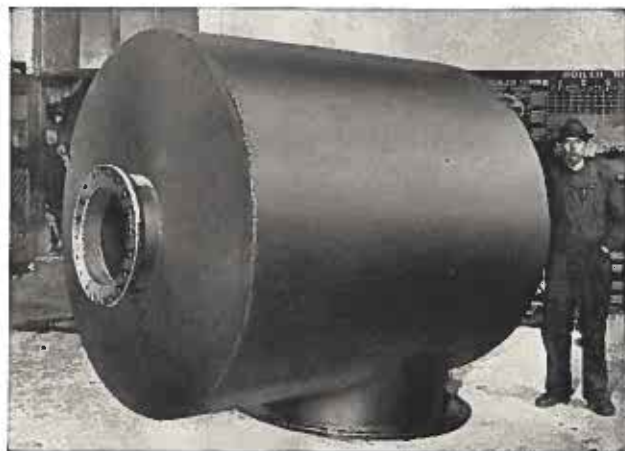

“Standard Special” Oil Separator for 28” Vacuum

INFORMATION NEEDED FOR QUOTATION

The Engineering Department of the Wright-Austin Company will advise the best equipment to use, with full information and prices, if it is informed of the conditions under which a Separator is intended to operate. THE IMPORTANCE OF THE FOLLOWING INFORMATION CANNOT BE OVER-EMPHASIZED, if prompt and effective service is to be rendered to persons ordering, requesting quotations, or asking information.

Steam Separators

In asking for prices, be sure to state:

- 1—Size of pipe connections.
- 2—Working steam pressure.
- 3—Direction of steam flow through separator.
- 4—Degrees of superheat.
- 5—Standard or Extra Heavy Schedule.

Oil Separators

State:

- 1—Size of pipe connections.
- 2—Exhaust steam pressure.
- 3—Direction of steam flow through separator.

Vacuum Oil Separators

State:

- 1—Size of pipe connections.
- 2—Maximum and minimum vacuum.
- 3—Maximum pounds of steam per hour passing through separator.
- 4—Direction of steam flow through separator.

Compressed Air Separators

State:

- 1—Size of pipe connections.
- 2—Working air pressure.

Gas Separators

State:

- 1—Size of pipe connections.
- 2—Working pressure of gas.
- 3—Maximum volume of gas per hour.
- 4—Kind of gas and specific gravity.
- 5—Kind of oil to be eliminated and specific gravity.
- 6—Approximate amount of oil to be removed.

WRIGHT-AUSTIN ENGINEERING SERVICE

The Wright-Austin Company is always ready to answer questions, furnish information or give engineering advice on the selection and installation of its product.

This Bulletin contains information required for selecting apparatus to meet ordinary conditions and we believe that the data and suggestions contained will be found sufficient to cover most installations; but when extraordinary conditions arise, or when there is doubt about the selection of equipment, the Wright-Austin Engineering Service will be found invaluable.

Wright-Austin Engineers are drainage experts and frequently plan entire drainage systems for prospective customers, or for manufacturers of heating and drying machinery.

Engineers and Managers should feel free to call upon this service at any time. It will be cheerfully rendered and there will thus be made available to them the accumulated experience of thirty-five years of successful production.

Vertical Steam Separators

TYPE "A"

Wright-Austin Live Steam Vertical Separator

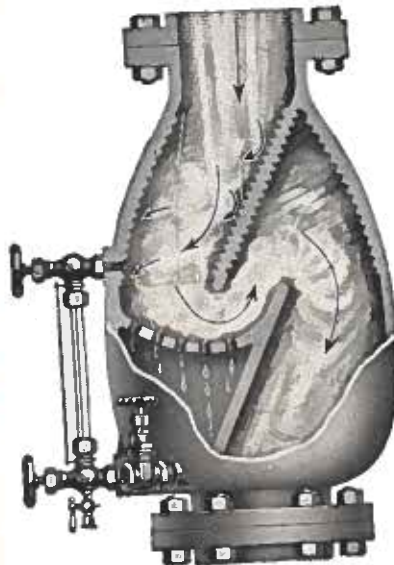

The Type "A" is designed for installation in vertical steam lines, usually just above the throttle of the engine. It is of the baffle type, having very large internal areas.

One feature contributing to the successful operation of this Separator is that the baffle plate is not set at right angles to the entering steam current, but is set so that when the incoming steam is impinged against it and rebounds to the opposite wall of the Separator, the particles of moisture are driven down the deep, slanting corrugations on walls and baffle, entirely out of the course of the steam, and into the well below where they are drained off. Passing around the lower edge of the baffle, the flow of the steam is completely reversed by a quick, sharp turn upward.

This sudden reversal whips out the final trace of moisture, which continues downward and is caught in the open baffle over the well below.

Every Separator should be automatically drained by an efficient steam trap. See page 45.

Prices and Dimensions

Pipe Size	Dimensions in Inches					Wgt. Lbs.	Standard List Price Includes Water Gauge Only	Ex. Hvy. List Price Includes Water Gauge Only	Code Word
	A Stand-ard 125 lbs.	A Extra Heavy 250 lbs.	B	C	Drain				
1 1/2	S. E.	S. E.	12	7	1 1/2	45	\$27.50	\$27.50	Abate
2	S. E.	S. E.	12	7	1 1/2	45	32.50	32.50	About
2 1/2	7	7 1/2	13	8	3/4	85	40.00	44.00	Above
3	7 1/2	8 1/4	15 1/4	9	3/4	115	46.00	48.00	Actor
3 1/2	8 1/2	9	16 3/4	10	3/4	135	50.00	54.00	Alert
4	9	10	18	11	3/4	170	60.00	65.00	Adrip
4 1/2	9 1/4	10 1/2	20	12	3/4	215	75.00	78.00	Admit
5	10	11	22 1/4	13	1	240	85.00	92.00	Adult
6	11	12 1/2	25 1/4	15	1	330	108.00	120.00	Acute
7	12 1/2	14	28 1/2	17	1 1/4	440	150.00	162.00	Adept
8	13 1/2	15	31 1/2	19	1 1/4	575	185.00	220.00	Adore
10	16	17 1/2	37	23	1 1/2	910	280.00	310.00	Affix
12	19	20 1/2	40 1/4	25 1/2	1 1/2	1080	325.00	370.00	Alive

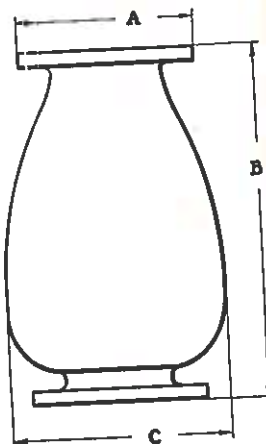

Order or inquiry must state whether Standard or Extra Heavy Separator is desired.
 1 1/2" and 2" Extra Heavy sizes can be furnished with flanged ends; 1 1/2"-\$32.00; 2"-\$37.00.
 Companion flanges, also drain valve and nipple, can be furnished at extra cost. For prices, also flange drilling, see pages 40-41.
 Stock sizes—1 1/4" to 12", inclusive, both Standard and Extra Heavy.
 For Code Words for pressures, see page 125.
 Also made in cast steel for superheat. Prices quoted upon receipt of: 1—Pipe Size. 2—Working Pressure. 3—Degrees of Superheat.

TYPE "M"

Wright-Austin Live Steam Vertical Receiver Separator

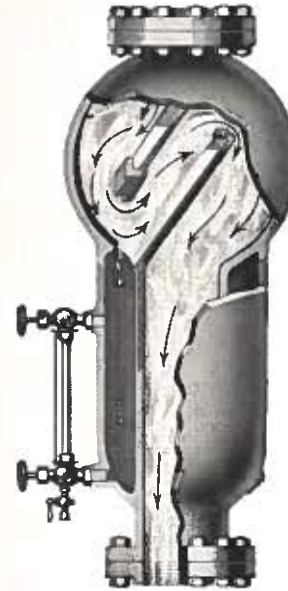

As a result of good receiver capacity, the Type "M" Vertical Steam Separator maintains a constant supply of dry steam at the throttle of the engine, with a reserve supply for emergencies such as sudden changes of load.

This Separator is intermediate in size and receiver capacity between the Type "A" and the Type "H" or "C" Separators shown on pages 10 and 11.

The action of the steam against the baffle plates is the same as in the other Wright-Austin Separators, the principle of which is described on page 3. Separation is positive and the condensate, being thrown into the receiver of the separator, is absolutely prevented from being picked up again by the flowing steam current.

There is a Wright-Austin Separator for every requirement and condition.

Prices and Dimensions

Pipe Size	Dimensions in Inches				Weight Pounds	List Price Includes Water Gauge Only	Code Word
	A	B	C	Drain			
1 1/2	S. E.	17	5 5/8	1 1/2	60	\$31.00	Major
2	S. E.	17	5 5/8	1 1/2	60	36.00	Mango
2 1/2	7 1/2	18	7 5/8	3/4	95	45.00	March
3	8 1/4	19 3/4	8	3/4	140	50.00	Medal
3 1/2	9	22 1/2	8 3/4	3/4	175	62.00	Meter
4	10	26 1/4	10 1/2	3/4	230	80.00	Might
4 1/2	10 1/2	30 1/2	12	3/4	305	100.00	Minor
5	11	34	13 1/4	1	360	118.00	Model
6	12 1/2	37 1/4	16	1	475	150.00	Motor
7	14	42 1/4	18 3/4	1 1/4	665	232.00	Murra
8	15	48 1/4	20	1 1/4	950	306.00	Monte
10	17 1/2	58	27	1 1/2	1550	493.00	Middy
12	20 1/2	64	31	1 1/2	2670	712.00	Merge
14	23	70	35	2	3155	950.00	Music

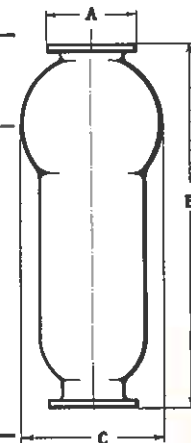

Regularly furnished with Extra Heavy flanges for working pressures up to 250 lbs. per square inch.
 Can also be supplied with flanges faced and drilled to 125 lb. Standard Schedule if especially ordered, at same price as the Extra Heavy.
 Companion flanges, also drain valve and nipple, can be furnished at extra cost. For prices, also flange drilling, see pages 40-41.
 Stock sizes 1 1/4" to 10" inclusive in Extra Heavy and Standard patterns.
 For Code Words for pressures, see page 125.
 Also made in cast steel for superheat. Prices quoted upon receipt of: 1—Pipe Size. 2—Working Pressure. 3—Degrees of Superheat.
 Flanged Ends including water gauge, List 1 1/2"-\$36.00; 2"-\$41.00.

TYPE "H"

Wright-Austin Live Steam Vertical Receiver Separator



The Type "H" Separator is designed to give the greatest possible volume of receiver capacity obtainable in a cast-in-one-piece Separator for modern high pressure service.

This Separator is especially valuable where steam is wet, due to priming of boilers, forcing of boilers, or long steam lines. Slugs of water can be removed and accommodated until the drainage system has a chance to operate.

It combines the basic principles necessary for thorough elimination of moisture from live steam, and is the first choice of many engineers.

Mounted over the throttle of engine or turbine, its cylindrical lines blend gracefully with the piping, adding an artistic touch to the plant, not obtainable by any other Separator.

Also its shape is such that it is more easily covered by magnesia or asbestos lagging than is the case with many other Separators.

Every Separator should be automatically drained by an efficient steam trap. See page 45.

Prices and Dimensions

Pipe Size	Dimensions in Inches				Weight Pounds	List Price Includes Water Gauge Only	Code Word
	A	C	D	Drain			
3	8 1/4	9 1/2	44 1/4	3/4	260	\$100.00	Habit
3 1/2	9	10 1/2	48 1/4	3/4	320	130.00	Harpy
4	10	11 7/8	52 1/4	3/4	450	170.00	Heave
4 1/2	10 1/2	11 3/8	56 1/4	3/4	500	185.00	Heath
5	11	14 1/4	60 1/4	1	730	245.00	Hepar
6	12 1/2	16 1/4	64	1	880	310.00	Hocus
7	14	18 3/8	68 1/4	1 1/4	1080	377.00	Honor
8	15	20 1/2	72 1/4	1 1/4	1300	445.00	House
10	17 1/2	22 1/2	76	1 1/2	1840	625.00	Human

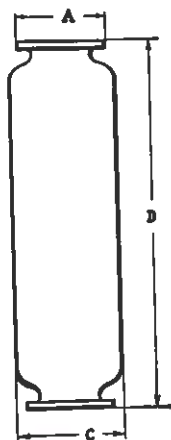

Regularly furnished with Extra Heavy flanges for working pressures up to 250 lbs. per square inch. Can also be supplied with flanges faced and drilled to 125 lb. Standard Schedule, if especially ordered, at same price as the Extra Heavy.

Companion flanges, also drain valve and nipple, can be furnished at extra cost. For prices, also flange drilling, see pages 40-41.

Made to order, shipment two to three weeks.

For Code Words for pressures, see page 125.

Also made in cast steel for superheat. Prices quoted upon receipt of: 1—Pipe Size. 2—Working Pressure 3—Degrees of Superheat.

TYPE "C"

Wright-Austin Live Steam Vertical Steel Receiver Separator

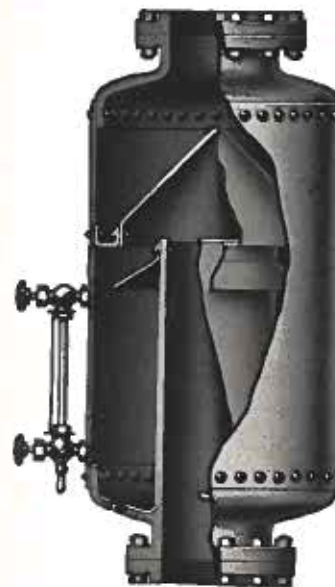

The Type "C" Separator can be built for any pressure or superheat. Steam enters at the top and strikes a cone, which throws the condensation downward against the sides of the separator, past the guard attached to the outlet pipe. From this point, the steam must then make two sharp turns, forcing thorough separation by throwing the small particles of moisture completely out of the steam down to the drain below. The guard around the vertical outlet stops any moisture from being drawn up into the out-flowing steam current.

Standard sizes are given below, but the diameter and length of Type "C" can be changed to suit any conditions or cubical capacity desired. The general practice is three times the cubical capacity of the engine cylinder.

Type "C" is built and tested to the rigid requirements of the A. S. M. E. Code for Unfired Pressure Vessels.

There is a Wright-Austin Separator for every requirement or condition.

Weights and Dimensions

Pipe Size	Dimensions in Inches				Weight Lbs.	Code Word
	A	B	C	Drain		
3	8 1/4	42	18	3/4	650	Cedar
3 1/2	9	42	18	3/4	650	Celts
4	10	46	22	1	800	Cable
4 1/2	10 1/2	46	22	1	800	Cerad
5	11	46	22	1	800	Corne
6	12 1/2	46	22	1	800	Cameo
7	14	48	24	1 1/4	900	Canon
8	15	48	24	1 1/4	900	Carol
10	17 1/2	50	26	1 1/2	1000	Carry
12	20 1/2	56	30	2	1100	Cieon
14	23	62	34	2	2080	Copse
16	25 1/2	68	38	2	2500	Costa
18	28	74	42	2 1/2	2900	Count
20	30 1/2	80	46	2 1/2	3500	Crown

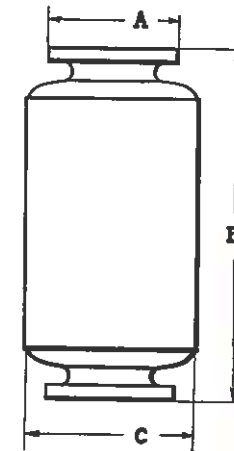

Special prices on application.

When ordering or obtaining prices, be sure to give: 1—Size of Pipe Connections. 2—Working Steam Pressure. 3—Degrees of Superheat—if any. 4—Direction of Steam Flow through Separator.

Size of receiver may be varied from the above to suit special requirements or conditions. State dimensions, or cubic volume desired.

For Code Words for pressures, see page 125.

Horizontal Steam Separators

TYPE "B"

Wright-Austin Live Steam Horizontal Separator



The Type "B" is an ideal Separator for limited head or side room. No part of the Separator projects beyond the outside diameter of the pipe flange, except the body which hangs directly underneath. It can be installed in a horizontal pipe line that is tight up against the ceiling, or close up to parallel pipes or wall on either side.

The flow of steam may be passed through the Type "B" Separator in either direction with equal efficiency.

Upon striking the inclined baffle, the condensation is driven down the deep, slanting corrugations out of the path of the steam current. Any moisture not caught by the upper baffle and by the inner wall grooves, is finally separated by additional baffles located just over the well or receiver of the separator.

This corrugated construction is a distinctive Wright-Austin feature, being an important contribution toward the efficiency of the Type "B" Separator, making it one of the most popular of our entire line.

Every Separator should be automatically drained by an efficient steam trap. See page 45.

Prices and Dimensions

Pipe Size	Dimensions in Inches					Wgt. Lbs.	Standard List Price Includes Water Gauge Only	Extra Heavy List Price Includes Water Gauge Only	Code Word
	A Std 125 lbs.	A Extra Hvy. 250 lbs.	B	C	Drain				
1 1/2	S. E.	S. E.	10 1/2	9	1/2	45	\$23.00	\$23.00	Bacca
2	S. E.	S. E.	10 1/2	9	1/2	45	26.00	26.00	Bravo
2 1/2	7	7 1/2	13 1/4	12	3/4	115	33.00	34.00	Baker
3	7 1/2	8 1/4	15 1/4	13	3/4	125	38.00	41.00	Bandy
3 1/2	8 1/2	9	16	14	3/4	165	48.00	51.00	Barge
4	9	10	18 1/4	15	3/4	215	60.00	63.00	Brier
4 1/2	9 1/4	10 1/2	19 1/4	17	3/4	265	68.00	74.00	Baton
5	10	11	20 3/4	20 3/4	1	285	78.00	81.00	Batch
6	11	12 1/2	24 1/4	22	1	435	110.00	122.00	Basis
7	12 1/2	14	27 1/4	25	1 1/4	600	156.00	160.00	Bison
8	13 1/2	15	30 1/4	29	1 1/4	835	204.00	216.00	Blade
10	16	17 1/2	31	36	1 1/2	1135	276.00	288.00	Bosky
12	19	20 1/2	36	40	1 1/2	1580	372.00	400.00	Borax
14	21	23	39	42	2	1625	450.00	470.00	Bruin

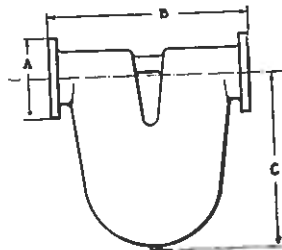

Order or inquiry must state whether Standard or Extra Heavy Separator is desired. 1 1/2" and 2" Extra Heavy sizes can be furnished with flanged ends; 1 1/2"—\$23.00; 2"—\$31.00. Companion flanges, also drain valve and nipple, can be furnished at extra cost. For prices, also flange drilling, see pages 40-41. Stock sizes—1 1/2" to 12" inclusive, both Standard and Extra Heavy. For Code Words for pressures, see page 125. Also made in cast steel for superheat. Prices quoted upon receipt of: 1—Pipe Size. 2—Working Pressure. 3—Degrees of Superheat.

TYPE "E"

Wright-Austin Live Steam Horizontal Receiver Separator

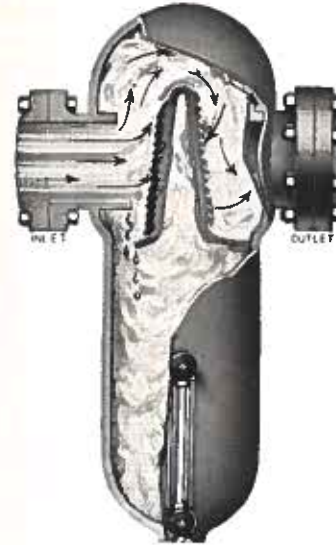

The Type "E" Separator is one of the most effective types manufactured. There are thousands in use and the elimination of moisture is unusually perfect.

The extended inlet, overshoot, corrugated angle baffle and specially protected outlet are developments in design which result in ideal separation. Moisture catches in the corrugations of the baffle and is carried to the sides, thus going into the receiver, while the steam for the most part goes over the top of the baffle.

The Separator is cast in one piece without any joints or gaskets, thus preventing leaks and eliminating maintenance. The internal areas are very large, permitting complete separation of moisture, also, as a result, there is no back pressure. The receiver provides a reserve for sudden fluctuations of load or slugs of water and is midway in capacity between the Type "B" and Type "G" Separators.

There is a Wright-Austin Separator for every requirement or condition.

Prices and Dimensions

Pipe Size	Dimensions in Inches					Wgt. Lbs.	List Price Includes Water Gauge Only	Code Word
	A	B	C	D	Drain			
1 1/2	5	10	10 1/2	S. E.	1/2	60	\$26.00	Equip
2	5	10	10 1/2	S. E.	1/2	60	28.00	Eagle
2 1/2	6	12	11	7 1/2	3/4	125	36.00	Eblis
3	6 1/2	13	12 1/4	8 1/4	3/4	155	43.00	Eclat
3 1/2	7 1/2	15	13 3/8	9	3/4	170	54.00	Edict
4	9	17	14 3/4	10	3/4	230	66.00	Eider
4 1/2	10	20	16 3/4	10 1/2	3/4	310	78.00	Eikon
5	11	23	19	11	1	470	108.00	Eland
6	12	26	21	12 1/2	1	565	132.00	Elate
7	13 3/4	29	22 3/4	14	1 1/4	715	168.00	Elbow
8	16	32	24	15	1 1/4	880	224.00	Enjoy
10	20	38	30	17 1/2	1 1/2	1300	372.00	Ensue
12	23	41	34	20 1/2	1 1/2	1800	462.00	Enter
14	26	44	39 3/4	23	2	3055	800.00	Emery

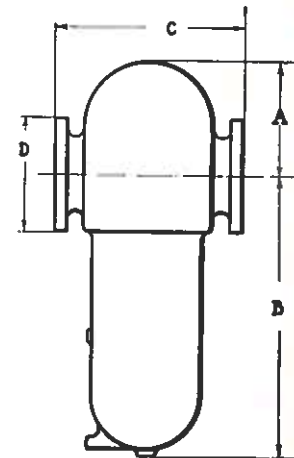

Regularly furnished with Extra Heavy flanges for working pressures up to 250 lbs. per square inch. Can also be supplied with flanges faced and drilled to 125 lb., Standard Schedule if especially ordered, at same price as the Extra Heavy. Companion flanges, also drain valve and nipple, can be furnished at extra cost. For prices, also flange drilling, see pages 40-41. Stock sizes 1 1/2" to 10" inclusive in Extra Heavy and Standard pattern. For Code Words for pressures, see page 125. Also made in cast steel for superheat. Prices quoted upon receipt of: 1—Pipe Size. 2—Working Pressure. 3—Degrees of Superheat. Flanged Ends including water gauge, List 1 1/2"—\$30.00; 2"—\$33.00.

TYPE "D"

Wright-Austin Live Steam Horizontal Steel Receiver Separator

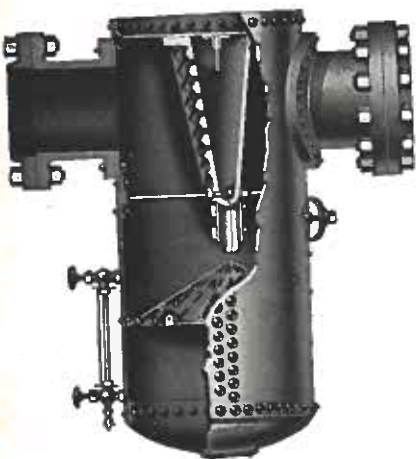

Designed with very low head, the Type "D" Separator can be installed to advantage where pipe lines run close to ceiling or overhead obstructions. The illustration at the top of page 27, in this bulletin, although showing a "Standard Special" Separator gives a good impression of the way in which a Type "D" Separator appears when installed in close quarters.

Incorporated in this apparatus will be found some of the special features already described in others of our patterns. The baffle is similar to that employed in the Type "G" except it is of the undershot type, the lower part of which forms a trough draining to the sides. The cone in the lower part prevents the steam from agitating whatever water may be in the bottom of the receiver.

Like the Type "G" it is designed for the most exacting service for any working pressure or superheat conditions.

Built to A. S. M. E. Code specifications throughout.

Every Separator should be automatically drained by an efficient steam trap. See page 45.

Weights and Dimensions

Pipe Size	Dimensions in Inches						Wgt. Lbs.	Code Word
	A	B	C	D	E	Drain		
8	50	34	18	39 1/2	15	1 1/4	700	Dedar
10	55	40 1/2	22	44	17 1/2	1 1/2	1050	Doily
12	63 1/2	44	24	50	20 1/2	2	1300	Dingo
14	72 1/2	47	26	56	23	2	2000	Drawl
16	74 1/2	50	28	59	25 1/2	2	2200	Drill
18	81	53	30	62	28	2 1/2	2500	Dynam

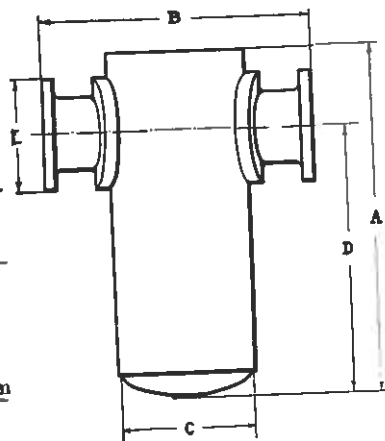

Special prices on application.

When ordering or obtaining prices, be sure to give: 1—Size of Pipe Connections. 2—Working Steam Pressure. 3—Degrees of Superheat—if any.

Size of receiver may be varied from the above to suit special requirements or conditions. State dimensions or cubic volume desired.

For Code Words for pressures, see page 125.

TYPE "G"

Wright-Austin Live Steam Horizontal Steel Receiver Separator

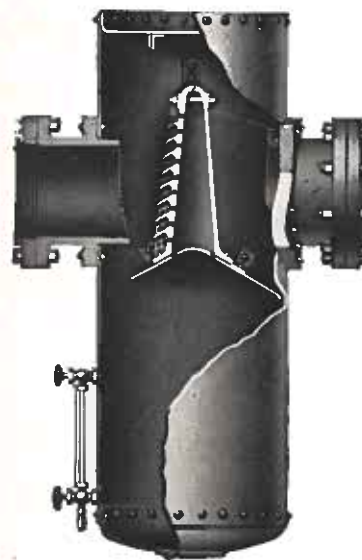

Extra large receiver capacity combined with the utmost efficiency are obtainable in the Type "G" Separator.

To stop vibration of steam line or slugs of water from priming boilers, this Separator is highly recommended. It is built for the highest working pressures, also with cast steel nozzles for superheat, conforming in all respects to the A. S. M. E. Code for Unfired Pressure Vessels.

A perfect system of drainage grooves in the baffle leads to the sides, and in addition, much of the condensation in the steam is driven through perforations also draining to the sides.

Where desired to have two or more extra inlets or outlets connecting to branch pipes, this form of separator lends itself readily to such construction, by a special arrangement of baffles.

There is a Wright-Austin Separator for every requirement or condition.

Weights and Dimensions

Pipe Size	Dimensions in Inches						Wgt. Lbs.	Code Word
	A	B	C	D	E	Drain		
10	21	40	22	40 1/2	17 1/2	1 1/2	1350	Great
12	24	48	24	44	20 1/2	2	1600	Ghaut
14	28	54	26	47	23	2	2250	Gager
16	32	60	28	50	25 1/2	2	2850	Gaily
18	36	64	30	53	28	2 1/2	3200	Girth
20	38	68	32	56 1/2	30 1/2	2 1/2	3640	Globe
22	40	72	34	59 1/2	33	3	4180	Goral
24	44	76	36	63	36	3	4720	Grail
26	48	80	38	66 1/4	38 1/4	3	5200	Guard

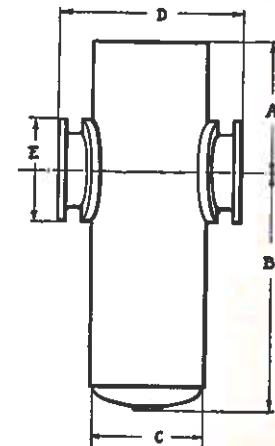

Special prices on application.

When ordering or obtaining prices, be sure to give: 1—Size of Pipe Connections. 2—Working Steam Pressure. 3—Degrees of Superheat—if any.

Size of receiver may be varied from the above to suit special requirements or conditions. State dimensions or cubic volume desired.

For Code Words for pressures, see page 125.

TYPE "L"

Wright-Austin Live Steam Horizontal Steel Receiver Separator



The Type "L" Separator fills an important place between the Type "E" and the Types "D" and "G" just described. The Separator Head containing the baffle has all the excellent features of the Type "E," namely, overshot, corrugated, angle baffle, extended inlet and flanged ring outlet. The entire head is cast in one piece, so that there is no maintenance for this part of the Separator.

The receiver is made of riveted steel and is very much larger than that of the Type "E," in fact it is larger than the built-in receivers of the Type "D" or Type "G" Separators, thus combining the advantages of the cast iron type of Separator with those of the riveted steel type. There is only one joint, namely, where the head joins the receiver. If desired, receivers of special capacity can be built as "Standard Specials" at small extra cost and used with the Type "L" Separator Head. See pages 22-27 inclusive.

Built and tested to A. S. M. E. Code requirements.

Every Separator should be automatically drained by an efficient steam trap. See page 45.

Weights and Dimensions

Pipe Size	Dimensions in Inches						Weight Lbs.	Code Word
	A	B	C	D	E	Drain		
3	6 1/2	36	12	12 1/4	8 1/4	3/4	350	Label
4	9	40	13 1/2	14 3/4	10	3/4	450	Latch
5	11	45	16	19	11	1	680	Latin
6	12	50	18	21	12 1/2	1	900	Layer
7	13 3/4	56	20	22 3/4	14	1 1/4	1150	Legal
8	16	64	22	24	15	1 1/4	1350	Livre
10	20	80	26	30	17 1/2	1 1/2	2190	Loach
12	23	90	30	34	20 1/2	2	2650	Logie
14	26	102	34	39 3/4	23	2	3750	Lotus
16	29	112	38	41 1/2	25 1/2	2	4600	Lunar
18	32	120	42	43	28	2 1/2	5765	Lyric
20	35	130	46	45	30 1/2	2 1/2	6700	Lusty

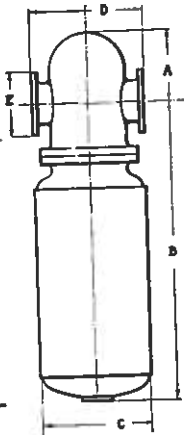

Special prices on application.
 When ordering or obtaining prices, be sure to give: 1—Size of pipe connections. 2—Working steam pressure. 3—Degrees of superheat—if any.
 Size of receiver may be varied from the above to suit special requirements or conditions. State dimensions or cubic volume desired.
 For Code Words for pressures, see page 125.

Angle Steam Separators

TYPE "N"

Wright-Austin Live Steam Angle Receiver Separator



Angle Separators made of cast semi-steel have a distinct place in the separator field. They save piping, as all Angle Separators do, and have the special advantage of being cast in one piece, thus eliminating joints and gaskets, also reducing first cost.

The Type "N" Separator is especially suitable for installation where piping, descending from the ceiling, enters the angle throttle valve of an engine horizontally.

This Separator is designed for steam flow in either direction, and has a receiver of good capacity. It makes an attractive appearance when installed. Its design is the result of much careful experimenting. Baffle and steam areas are sufficient for complete elimination of moisture.

There is a Wright-Austin Separator for every requirement or condition.

Prices and Dimensions

Pipe Size	Dimensions in Inches						Weight Lbs.	List Price Includes Water Gauge Only	Code Word
	A	B	C	D	E	Drain			
2 1/2	7 1/2	4 3/4	5 3/4	8 1/4	4 3/4	3/4	95	\$36.00	Nappy
3	8 1/4	5	6 3/4	12	5	3/4	140	42.00	Needy
3 1/2	9	5 1/2	7 3/4	12	5 1/2	3/4	175	53.00	Neuro
4	10	6 1/2	8 3/4	16 1/2	6 1/2	3/4	230	64.00	Naugo
4 1/2	10 1/2	7	10 3/8	20	7	3/4	305	80.00	Nobby
5	11	8 1/4	11	23	8	1	360	96.00	Noble
6	12 1/2	9	13	25	9	1	475	120.00	Noise
7	14	11	15	28	11	1 1/4	665	187.00	Notch
8	15	11 1/2	17	33 1/2	11 1/2	1 1/4	950	246.00	Notus
10	17 1/2	15	21	40	15	1 1/2	1550	396.00	Novel
12	20 1/2	17	25 1/2	43	17	1 1/2	2670	570.00	North

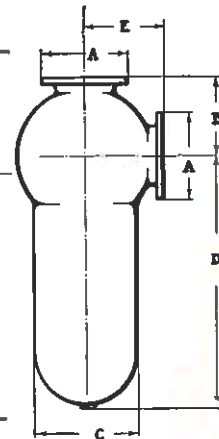

Regularly furnished with Extra Heavy flanges for working pressures up to 250 lbs. per square inch.
 Can also be supplied with flanges faced and drilled to 125 lb. Standard Schedule, if especially ordered, at same price as the Extra Heavy.
 Companion flanges, also drain valve and nipple, can be furnished at extra cost. For prices, also flange drilling, see pages 40-41.
 Made to order—shipment three weeks.
 For Code Words for pressures, see page 125.
 Also made in cast steel for superheat. Prices quoted upon receipt of: 1—Pipe Size. 2—Working Pressure. 3—Degrees of Superheat.

TYPE "O"

Wright-Austin Live Steam Angle Receiver Separator

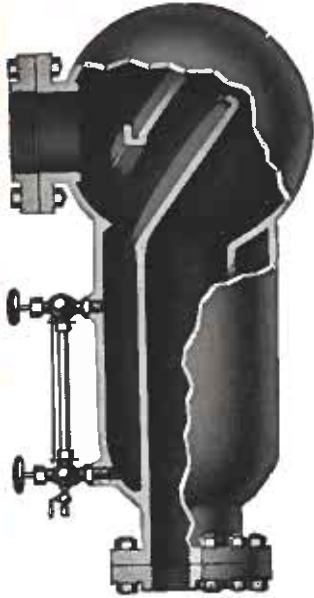

Where low head room or a short pipe connection from horizontal supply pipe down to throttle is desirable, the Type "O" Separator is the answer—it exactly fits such a condition.

It provides the benefits of efficient separation in a minimum of pipe space, also taking the place of an elbow and short pipe, thus eliminating several joints.

This Separator is similar to the Type "N," described on the preceding page, except for the arrangement of connections. It has very good receiver capacity and is designed for complete elimination of moisture without back pressure or loss by friction.

Every Separator should be automatically drained by an efficient steam trap. See page 45.

Prices and Dimensions

Pipe Size	Dimensions in Inches						Weight Lbs.	List Price Includes Water Gauge Only	Code Word
	A	B	C	D	E	Drain			
2½	7½	3¾	5¾	13¼	4¾	¾	95	\$36.00	Obese
3	8¾	4	6¾	14¾	5	¾	140	42.00	Oasis
3½	9	4½	7¾	18	5½	¾	175	53.00	Obore
4	10	5½	8¾	19½	6½	¾	230	64.00	Ochre
4½	10½	6	10¾	23	7	¾	305	80.00	Offer
5	11	6¾	11	26	8	1	360	96.00	Orcin
5½	11½	7¾	13	28	9	1	475	120.00	Ortho
6	12½	8¾	15	31	11	1¼	665	187.00	Ovule
7	14	9¾	17	36½	11½	1¼	950	246.00	Overt
8	15	10¾	21	43	15	1½	1550	396.00	Ozone
10	17½	13½	25½	47	17	1½	2670	570.00	Ozice

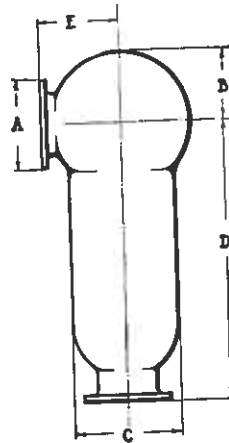

Regularly furnished with Extra Heavy flanges for working pressures up to 250 lbs. per square inch. Can also be supplied with flanges faced and drilled to 125 lb. Standard Schedule, if especially ordered, at same price as the Extra Heavy.

Companion flanges, also drain valve and nipple, can be furnished at extra cost. For prices, also flange drilling, see pages 40-41.

Made to order—shipment three weeks.
For Code Words for pressures, see page 125.

Also made in cast steel for superheat. Prices quoted upon receipt of: 1—Pipe Size. 2—Working Pressure. 3—Degrees of Superheat.

TYPE "I"

Wright-Austin Live Steam Angle Steel Receiver Separator



The Type "I" Separator is designed to meet all requirements for an Angle Separator. It saves piping, elbows, etc. in many places where the use of horizontal or vertical Separators would be impracticable or awkward.

It can be made with connections arranged as shown in the illustration, to pass steam through in either direction, or it can be made with connections at side and bottom, to pass steam in either direction. It can also be made with several inlets or outlets if desired, becoming then a "Standard Special" as described on page 22.

This type of Separator is especially suitable for use with turbines and can be placed above or below the floor level of the turbine with good results. It has large receiver capacity, large steam storage capacity and eliminates moisture completely. See pages 2 and 27 for photographs of Separators of this general type installed with turbines.

Type "I" Separators are built and tested to A.S.M.E. Code requirements for any working pressure or superheat.

There is a Wright-Austin Separator for every requirement or condition.

Prices and Dimensions

Pipe Size	Dimensions in Inches						Weight Lbs.	Code Word
	A	B	C	D	E	Drain		
6	12½	18	25½	16	15	1	495	Icono
8	15	21	32	18	17	1¼	780	Ictus
10	17½	25	40	22	21	1½	1085	Inlay
12	20½	29	48	24	22	2	1585	Image
14	23	33	56	26	24	2	1610	Impel
16	25½	38	60	30	25	2	2275	Incur
18	28	41	64	32	28	2½	2350	Infix
20	30½	44	68	36	31	2½	2600	Index

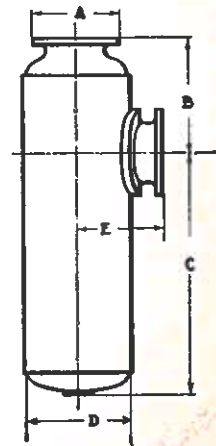

Special prices on application.

When ordering or obtaining prices, be sure to give: 1—Size of Pipe Connections. 2—Working Steam Pressure. 3—Degree of Superheat—if any. 4—Direction of Steam Flow through Separator.

Size of receiver may be varied from the above to suit special requirements or conditions. State dimensions or cubic volume desired.

For Code Words for pressures, see page 125.

**TYPICAL INSTALLATIONS OF WRIGHT-AUSTIN
STANDARD TYPE LIVE STEAM SEPARATORS**

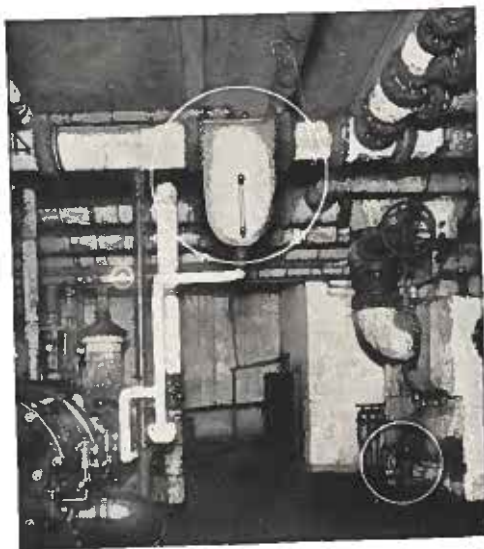

**A 10" Type "B" Horizontal Steam Separator
Showing Installation Near Ceiling**

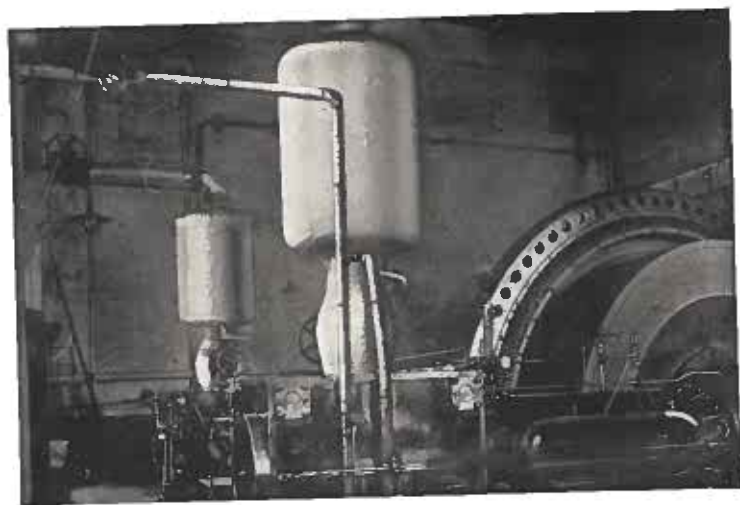

**Two 10" Type "C" Vertical Riveted Steel Receiver Steam Separators at
the Plant of The Corn Products Refining Co., Pekin, Ill.**

WHERE WRIGHT-AUSTIN SEPARATORS ARE USED



Courtesy American Architect

**Roosevelt Hotel, New York City
Seven Wright-Austin Separators (See Page 25)**

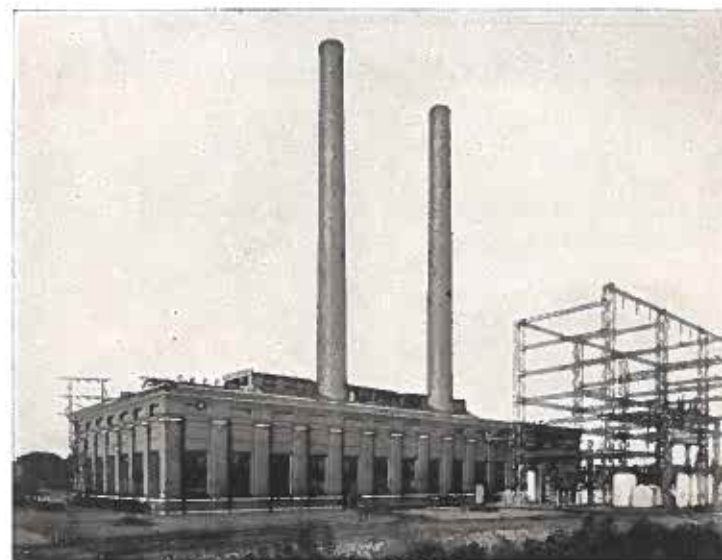

**The Battle Creek Plant of Consumers Power Co.
Serving Central Part of State of Michigan**

“Standard Special” Steel Receiver Steam Separators for High Pressure—Superheat



Horizontal “Standard Special” Separator for 250 Lbs. Pressure, 150° F. Superheat at Rochester Steam Plant of Rochester Gas and Electric Co., Rochester, N. Y.

Certain Riveted Steel Receiver Separators have received the name “Standard Specials” because they are “Special” Separators, designed to meet customer’s conditions, but are made up from “Standard” parts and to a large extent, from “Standard” plans. The Wright-Austin Company is particularly well equipped for this work. Note the great variety of “Standard Special” Steam Separators illustrated on this page and on pages following.

“Standard Specials” cost less than special separators which are built to order in every part, because more than half the work on them has been done in the preparation of standard parts. A customer receives the benefit of this in the prices quoted.

“Standard Specials” are better designed than most special separators because the plans from which they are built have been perfected in general arrangement, during thirty-five years of successful manufacture, and only need to be modified as to size. Moreover, there are plans in the Wright-Austin files to suit every type of connection.



Designed for Superheated Steam at 250 Lbs. Pressure, for One of the Plants of The International Nickel Co.

“Standard Specials” are completely satisfactory because they are built TO **SUIT CUSTOMER’S REQUIREMENTS** as to size, connection and shape, although they retain at the same time all the advantages of correct design and moderate cost.

“Standard Specials” have behind them the Wright-Austin Guarantee and Wright-Austin Service. The Wright-Austin Company makes only equipment that wears well and does its work at all times with little or no attention. It stands back of all apparatus which it makes as long as that apparatus is in use.

On many orders there is a very great saving of time in purchasing “Standard Specials” since no time is required to perfect designs or make patterns. The time between receipt of order and date of shipment is the time actually used in the shop.

Sometimes Separators can be specially constructed by others for less money than Wright-Austin “Standard Specials,” notwithstanding the extra cost of special patterns and plans; but the reduction in cost is gained by sacrificing the life and effectiveness of the apparatus. When these separators are built up to Wright-Austin quality, they cost more than Wright-Austin “Standard Specials.”

ADVANTAGES OF STEAM SEPARATORS BUILT TO ORDER

First—Complete elimination of moisture at high steam pipe velocities. Dangerous slugs of water carried over from priming or flooded boilers or from pockets in a pipe line will be completely removed, even at high steam velocities, by a Separator having baffle area and steam space especially proportioned to the velocity and volume of the steam.

Just as Standard Separators are built for average conditions and are satisfactory for all ordinary pressures, temperatures and steam velocities, so “Standard Special” Separators can be built and should be provided when average conditions are exceeded.

The Wright-Austin Company is always glad to submit plans to suit any and all conditions.

Second—Elimination of serious vibration in steam lines. A “Standard Special” Separator having large receiver capacity and designed for the particular location will furnish an extra large supply of steam as a reserve and a cushion, thus eliminating vibration and loss of efficiency.

Third—Convenient arrangement of connections to fit piping, thus avoiding pipe changes that frequently cost more than the price of the Separator.

For instance, a Separator may have inlets for two steam supply lines and an outlet to one engine, or it may have one inlet for steam supply and two or three outlets to as many engines. Inlets and outlets may occupy all sorts of peculiar positions with respect to one another. See illustrations on page 26.

Fourth—Adaptability to any pressure and any temperature in commercial use. An examination of the illustrations on this page and on succeeding pages will give an idea of the construction possible.

Fifth—Arrangement of dimensions and volume to suit purchaser. Practically any requirement can be readily met.

Sixth—"Standard Special" Separators are especially valuable with steam turbines. They prevent slugs of water and pipe scale or other foreign matter from striking the blades of the turbine and perhaps seriously eroding or injuring them.

Engineers thought formerly that separators were not necessary with steam turbines, especially if superheated steam was used. Practical experience, however, has taught engineers and manufacturers that slugs of water and dirt get into the turbine, even with superheated steam, eroding and tearing the blades, unless a Separator is installed on the steam line. It is especially true that superheaters will not evaporate water. A slug of water due to a priming boiler will frequently pass directly through a superheater into the steam piping and so into the turbine unless a Separator is provided to catch it.

One slug of water, or a priming or flooded boiler occasioned by accident, neglect or oversight in the boiler room, can put any turbine out of commission, causing loss of time and repairs costing the price of several Separators. The only preventive is a good receiver Separator automatically drained by a large capacity steam trap.

Soon it will be standard practice to install a Separator with every turbine. Because of high velocities, unusual conditions, high temperature and high pressures, these Separators must be "Standard Specials." See Illustration on page 2.

Seventh—These Separators permit the progressive engineer to work out his own ideas as to piping arrangements and design of apparatus without losing that expert knowledge of Separator construction which the Wright-Austin Company possesses.

CONSTRUCTION

Wright-Austin "Standard Specials" are constructed strictly in accordance with the A. S. M. E. Code for Unfired Pressure Vessels. The steel used is "flange steel" as defined in the Code. The working stress is taken at 11,000 lbs. per square inch and riveted joints are designed with a factor of safety of Five to One.

Extra precautions are taken to make Separators tight, and every one is tested by hydraulic pressure to $1\frac{1}{2}$ times working pressure or more before leaving the factory.

Nozzles and connections are made of semi-steel for temperatures below 450° F.; and for temperatures above that are made of cast steel or forged steel. Customers' wishes govern to a large extent in making up nozzles.

Joints can be welded, if customers prefer this to riveting.

"Standard Special" Separators can be made for any temperature, any volume, any pressure and any steam velocity in commercial use.



Some Possibilities in the Arrangement of Outlets

TYPICAL "STANDARD SPECIAL" STEAM SEPARATORS Made to Order from Wright-Austin Standard Parts and Plans



Group of Steam Separators for 150 Lbs. Pressure
Made for Roosevelt Hotel, New York

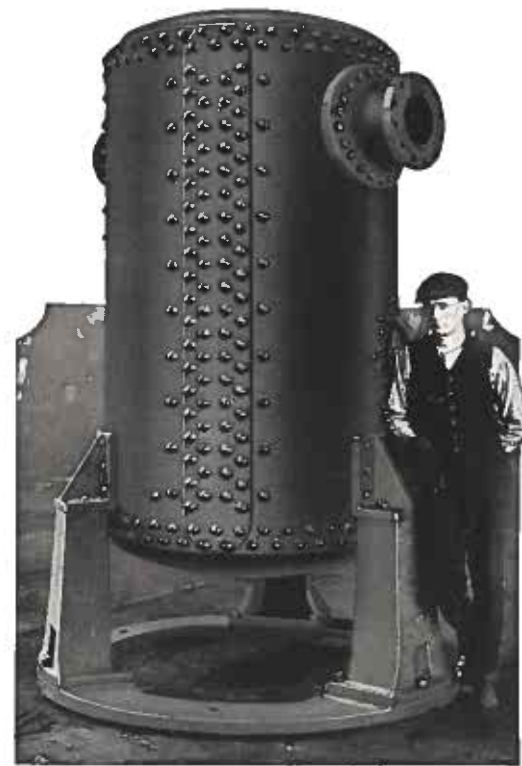

Large, High Pressure, Receiver Separator, Weighing $4\frac{1}{2}$ Tons

TYPICAL "STANDARD SPECIAL" STEAM SEPARATORS

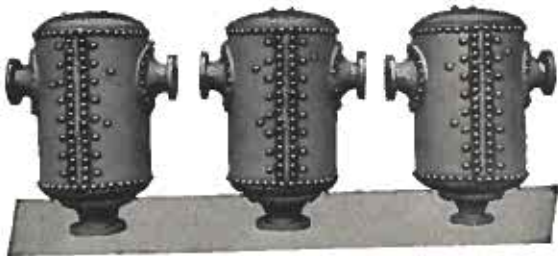

Each Separator Has Two Inlets at Sides and One Outlet at the Bottom
Fig. 1



Fig. 2



Fig. 3



Fig. 4

Wright-Austin
"Standard Specials"
Are Moderate in Price



Fig. 5

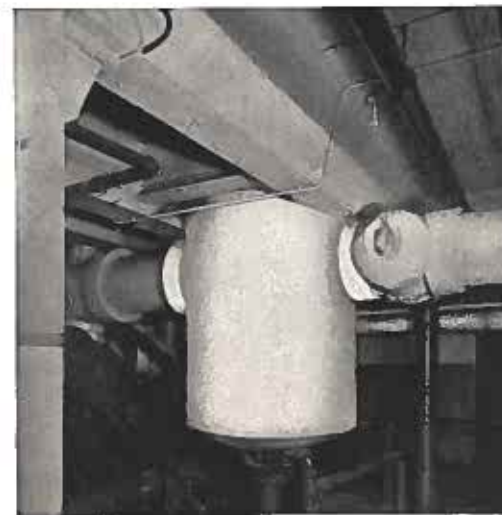

Fig. 6



Fig. 7

**TYPICAL INSTALLATIONS OF WRIGHT-AUSTIN
"STANDARD SPECIAL" RIVETED STEEL
STEAM SEPARATORS**



14" Horizontal Separator Handling 20,000 Lbs. of Steam per Hour
at 250 Lb. Pressure 150° F. Superheat, Installed Close to Ceiling



12" Angle Separator Under 275 Lb. Pressure
200° F. Superheat—Side Inlet and Top Outlet

Wright-Austin Oil Separators

MECHANICAL SEPARATION OF OIL FROM EXHAUST STEAM

In this method, advantage is taken of the natural law of gravity, and of the great difference in weight of the oil particles as compared with the weight of the steam in which they are contained.

The specific gravity of oil is about 0.70 as compared to water, while that of steam at 212° F. is about 0.0006, that is, the oil particles are about 1200 times heavier than the exhaust in which they are contained. Therefore, to separate the entrained oil from the steam, efficiently and completely, it is necessary to suddenly change the direction of the flow of the steam by an obstruction or baffle in the line.

The steam, being light, easily adjusts itself to the change of direction, but the heavier particles of oil and moisture, because of their great weight and the high velocity at which they are traveling, are not diverted with the steam around the baffle, but continue to shoot straight ahead, like the sand in a sand blast, into the collecting grooves provided for this purpose on the baffle. The baffle is continuously washed down clean of all oil by the impact of the condensate against it.

It is obvious that in multiple baffle Separators condensate cannot reach the rear baffles, in sufficient quantities to wash them down. They become gummy up in a short time, greatly decreasing the efficiency of a Separator and requiring frequent shut-downs for cleaning.

Furthermore, efficient separation by centrifugal action can be shown clearly to be impractical. According to the laws of inertia and momentum the small particles of oil and condensate, being heavier than steam, are not appreciably affected by variations in the course of the steam current, and will continue to move along in a practically straight line, unless stopped by actual contact with an obstruction in their course, such as a baffle. They only follow the course of the steam to a limited extent and cannot be successfully thrown out of the whirling mass.

To secure the desired results under various conditions, it is, therefore, only necessary to provide, in the steam line, a Separator of correct design and ample area, having a suitable baffle, to properly eliminate the oil from the steam, and keep it out by preventing it from again coming in contact with the steam flow.

Of course, every Separator should be automatically drained by a good Trap, having extra large valve opening so that it cannot become choked up with oil. This is necessary for carrying off the oil and condensation continuously. See page 45.

Oil Separators are used on exhaust steam lines from engines, pumps, compressors, etc., to remove the oil and purify the exhaust steam so that the condensate may safely be used as distilled water for boiler feed, ice making, textile and chemical processes, laundries or any other purposes for which either exhaust steam or purified condensate may be employed.

Purified Exhaust Steam contains about 90% of its original heat and is well adapted for heating or drying purposes.

Removal of oil from steam prevents accumulation of oily film on the inside parts of radiators, heating systems, dryers, etc. Such oily film greatly de-

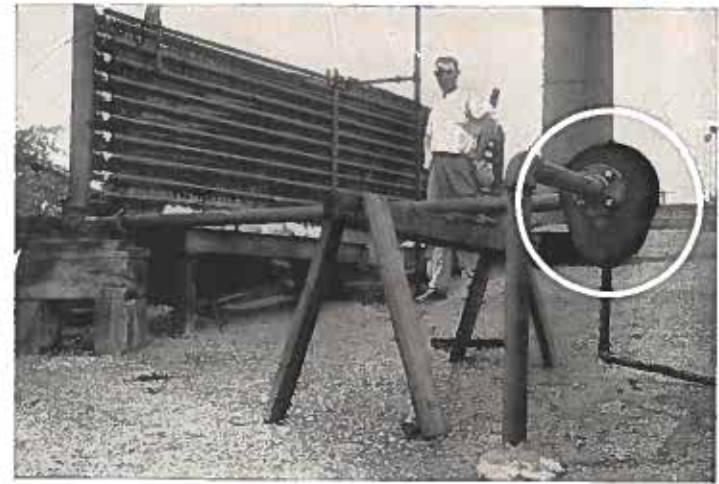

Type "S" Horizontal Oil Separator on the Roof of an Indiana Laundry

creases efficiency and production, offering even more heat resistance than an asbestos covering on the pipes.

Inside a steam boiler, a coating of oil 1/10 of an inch thick offers as much resistance to the transmission of heat from the fuel as a boiler plate 10 inches in thickness. Oil coated boilers are fuel wasters. They become leaky and predisposed to dangerous explosions. There is no escape for the oil, because it will not evaporate, and it continues to accumulate, frequently clotting in places and causing the plates to bulge and blister. Repair bills are the result, which are many times more costly than a Wright-Austin Oil Separator.

By separating oil from exhaust steam and using the purified condensate for boiler feed, rust and scale are reduced greatly. Condensate is distilled and deaerated water. It is free from the air and oxygen or other gases which cause rust and corrosion in steam pipes and heating systems. The life of a piping system is increased, expensive replacements are often avoided, and old piping, already pitted by corrosion, may have its life extended many years.

TYPE "S"

Wright-Austin Horizontal Oil Separator

The Wright-Austin Type "S" Oil Separator is designed so that the incoming steam, with oil in suspension, strikes a large circular baffle with deep corrugations. The small particles of oil and condensate are dashed into the grooves and flow down them into the bottom of the Separator.

Ample area is provided for the free passage of the steam all around the baffle, thus spreading out the steam into a comparatively thin volume or layer. The small particles of oil and condensate easily pass through the thin layer and are not picked up again by the steam. This is one of the very important and exclusive features of a Wright-Austin Oil Separator, found in no other make of Separators. Other Separators often wire draw the steam through ports, producing high steam velocity and frequently causing back pressure.



Type "S" Horizontal Oil Separator

Just inside the inlet of the Type "S" Oil Separator a trough is provided to catch the oil carried along the bottom of the pipe. From this trough a drain leads to the bottom of the Separator. On the rim of the baffle is a large, deep shoulder to catch any oil that may possibly have been carried across the face of the baffle.

Further on, an inner flange or ring is cast just inside the outlet which will absolutely prevent the escape of any oil that might still adhere to the walls of the Separator. Once eliminated, there is no possible way for oil to again come in contact with the steam flow and be carried beyond the Separator. The oil is not only separated, but is also segregated from the steam.

Because low pressure exhaust steam has a cubic volume several times greater than high pressure steam, larger internal areas are positively necessary. Pipe size for pipe size, the Type "S" Separator has several times greater baffle and steam passage than other standard Oil Separators, which means it is manifestly more efficient. For this reason oversize Type "S" Separators are not required. **HAVING THE LARGE INTERNAL AREA, THEY WILL NOT PRODUCE BACK PRESSURE.**

The Type "S" Wright-Austin Separator and its baffle are made in one solid casting, the baffle being attached to the body of the Separator by several lugs. There are no parts to become loose or misplaced, and no joints or gaskets, so it will never leak.

No oil can accumulate on the baffle, as it is continuously flushed clean by force of the hot condensate dashed against it. The Type "S" Oil Separator is **POSITIVELY SELF-CLEANING**. It will never be necessary to shut down the plant for cleaning, and when the Separator is installed, the job is forever finished—not a dollar further expense for renewals or upkeep of any kind—and the Separator is always at maximum efficiency. The first cost is the last cost.

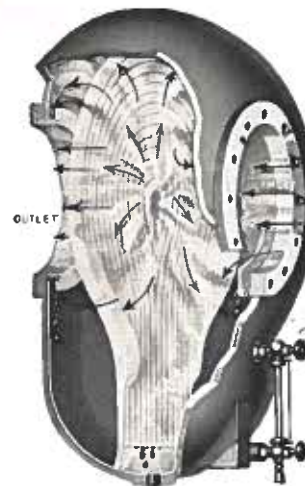

TYPE "S"
Horizontal Oil Separator Self-Cleaning
For Description See Pages 28, 29 and 30

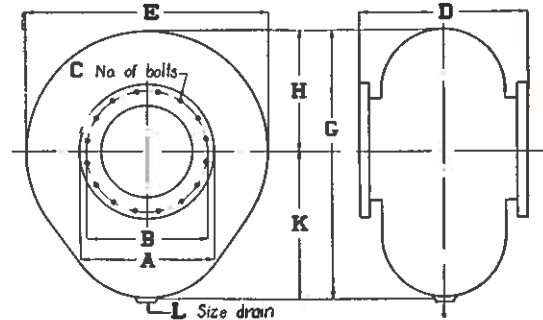

For Working Pressures Up to 50 Lbs.

Prices and Dimensions

Pipe Size	Dimensions in Inches									Wgt. Lbs.	List Price	Code Word
	A	B	C	D	E	G	H	K	L			
1 1/2	Scrd.	9 7/8	12	15 1/2	6 1/8	9 3/8	3/4	60	\$24.00	Saxon
2	Scrd.	10	12 1/8	15 1/2	6 1/8	9 1/8	3/4	70	27.00	Saury
2 1/2	7	5 1/2	4-5/8	10 1/4	14 1/2	17 7/8	7 1/8	10 1/8	1	150	42.00	Skiny
3	7 1/2	6	4-5/8	10 1/2	15	18	7 1/2	10 1/2	1	165	48.00	Satin
3 1/2	8 1/2	7	4-5/8	11	17	20	8 1/2	11 1/2	1	190	54.00	Sandy
4	9	7 1/2	8-5/8	12	19	23	9 1/2	13 1/2	1	235	72.00	Saint
4 1/2	9 1/4	7 3/4	8-3/4	13	21	25	10 1/2	14 1/2	1 1/4	290	80.00	Scare
5	10	8 1/2	8-3/4	15	23	27	11 1/2	15 1/2	1 1/4	370	100.00	Scene
6	11	9 1/2	8-3/4	17	25	30	12 1/2	17 1/2	1 1/2	475	122.00	Scope
7	12 1/2	10 3/4	8-3/4	17 1/2	27	33	13 1/2	19 1/2	1 1/2	580	156.00	Screw
8	13 1/2	11 3/4	8-3/4	18	29	36	14 1/2	21 1/2	1 1/2	670	170.00	Stick
10	16	14 1/4	12-7/8	19	32	40	16 1/2	23 1/2	1 1/2	830	228.00	Scull
12	19	17	12-7/8	20	34	42	17 1/2	24 1/2	1 1/2	1040	300.00	Sight
14	21	18 3/4	12-1	20	36	43	18 1/2	24 1/2	1 1/2	1160	348.00	Seize
16	23 1/2	21 1/4	16-1	22	40	44	20 1/2	23 1/2	1 1/2	1350	400.00	Sense
18	25	22 3/4	16-1 1/8	24	42	46	21 1/2	24 1/2	1 1/2	1530	456.00	Sepal
20	27 1/2	25	20-1 1/8	26	44	49	22 1/2	26 1/2	1 1/2	1660	528.00	Serve
22	29 1/2	27 1/4	20-1 1/4									Sewer
24	32	29 1/2	20-1 1/4									Sexto
26	34 1/4	31 3/4	24-1 1/4									Shack
28	36 1/2	34	28-1 1/4									Shear
30	38 3/4	36	28-1 3/8									Shore
32	41 3/4	38 1/2	28-1 1/2									Shrub
34	43 3/4	40 1/2	32-1 1/2									Shunt
38	48 3/4	45 1/4	32-1 5/8									Shift
42	53	49 1/2	36-1 5/8									Shyly
46	57 1/4	53 3/4	40-1 5/8									Sibyl
48	59 1/2	56	44-1 5/8									Siege

General Dimensions
Weights and Prices
on Application

Built in regular patterns up to 48". See special patterns on page 36.
Sizes 2 1/2" to 10" inclusive, built with nozzle flange connections, larger sizes with close flanges and furnished with stud bolts.

Eye bolts placed on 12" size and over.

Water gauges furnished on all sizes except 1 1/4" and 2".

Price includes water gauge only.

Companion flanges, drain valve and nipple can be furnished at extra cost. For prices and flange drilling see page 40.

Sizes up to and including 14" usually in stock.

**TYPICAL INSTALLATIONS OF WRIGHT-AUSTIN
TYPE "S" HORIZONTAL OIL SEPARATORS**

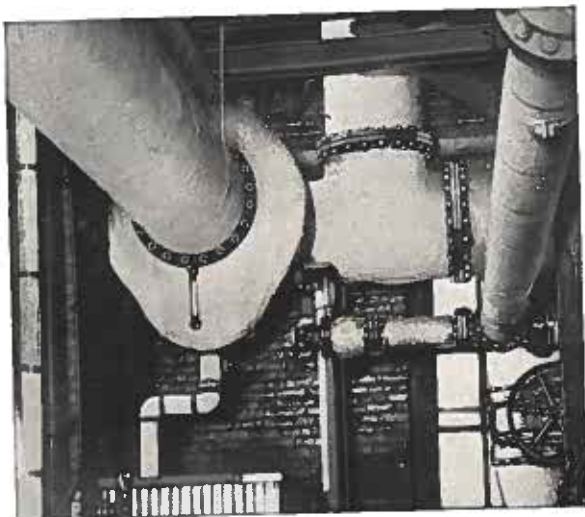

**A Type "S" Oil Separator in the Plant of a
Dyeing and Finishing Company**

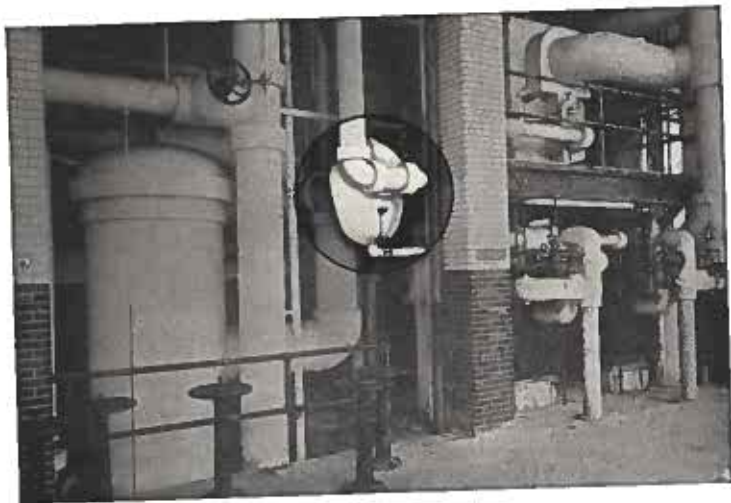

**An 8" Type "S" Horizontal Oil Separator in the
Power House of a Large Automobile Factory**

TYPE "R"

Wright-Austin Vertical Oil Separator—Self-Cleaning

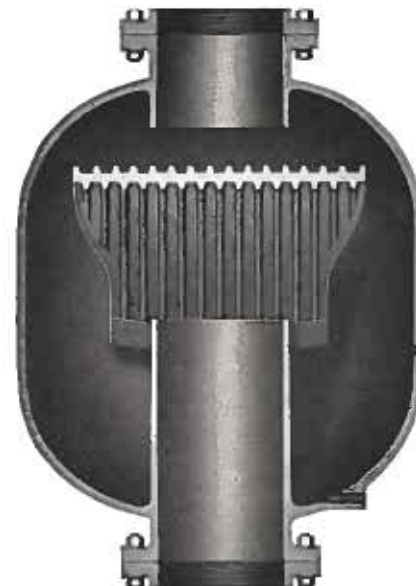

The Wright-Austin Type "R" Vertical Oil Separator embodies all the essentials for perfect oil separation—large clearance areas, large baffles, proper angles, etc.

It also is self-cleaning and will make a most excellent installation, where a vertical pattern is necessary.

The Type "R" has rightly earned its place beside the well known and nationally used Type "S" Oil Separator, described on pages 29 to 32 inclusive.

Every Separator should be automatically drained by an efficient steam trap. See page 45.

Prices and Dimensions

Pipe Size	Dimensions in Inches				Weight Pounds	List Price	Code Word
	Diam. Flanges	A	B	Drain			
4	9	15	20 ⁷ / ₈	1	230	\$66.00	Rally
5	10	17	24 ⁷ / ₈	1 ¹ / ₄	315	88.00	Rapid
6	11	18	28 ⁵ / ₈	1 ¹ / ₂	450	120.00	Ramie
7	12 ¹ / ₂	24 ¹ / ₂	37 ¹ / ₂	1 ¹ / ₂	785	330.00	Range
8	13 ¹ / ₂	25 ¹ / ₂	37 ¹ / ₂	1 ¹ / ₂	920	336.00	Raven
10	16	32 ³ / ₄	41 ¹ / ₈	1 ¹ / ₂	1280	366.00	Rebus
12	19	32 ³ / ₄	42	1 ¹ / ₂	1340	372.00	Redan

Price includes water gauge only. Flanges faced and drilled to A. S. M. E. Standard Schedule.

Companion flange, drain valve and nipple, can be furnished at extra cost.

For prices and flange schedules, see page 40.

See special patterns on page 36.

Made to order—shipment two weeks.

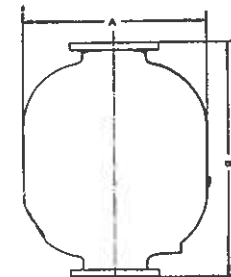

**For Working
Pressures
Up to 50 Lbs.**

TYPE "V"

Wright-Austin Vacuum Oil Separator

Vacuum Separators for the elimination of oil and moisture from exhaust steam, under medium and high vacuums, are always made of a suitable size for the operating conditions, because of the great difference in the cubic volume of a pound of steam under different vacuums. Every Separator is carefully figured out beforehand to suit the conditions and, for that reason, Wright-Austin Vacuum Oil Separator installations have been conspicuously successful.

Catchalls under vacuum for sugar and chemical evaporators are determined in the same way, insuring the highest efficiency.

Before we can definitely quote for vacuum service we must have—

- 1—Size of pipe connections.
- 2—Maximum pounds of steam per hour.
- 3—Maximum, normal and minimum inches of vacuum.
- 4—Direction of steam flow through separator.

When the oil is extracted from exhaust steam without impairing the vacuum, engineers concede the following advantages:

1—A Saving in Water, because the same feed water may be used continuously, with the addition of fresh water to replace loss by leakage, evaporation, etc. This is a saving of considerable importance in plants where water supply must be purchased.

2—A Saving in Fuel. The water of condensation delivered to the hot well contains a large number of heat units, most of which are saved in returning this water to the boilers.

3—A Saving in Boiler Repairs, etc. A supply of distilled water is obtained for boiler feed purposes. Being practically free from oil and other impurities, this water will prevent boiler trouble due to scale, foaming, leaky tubes, bulged plates or burnt shells and, for like reasons, the necessity for frequently cleaning the boilers is often avoided.

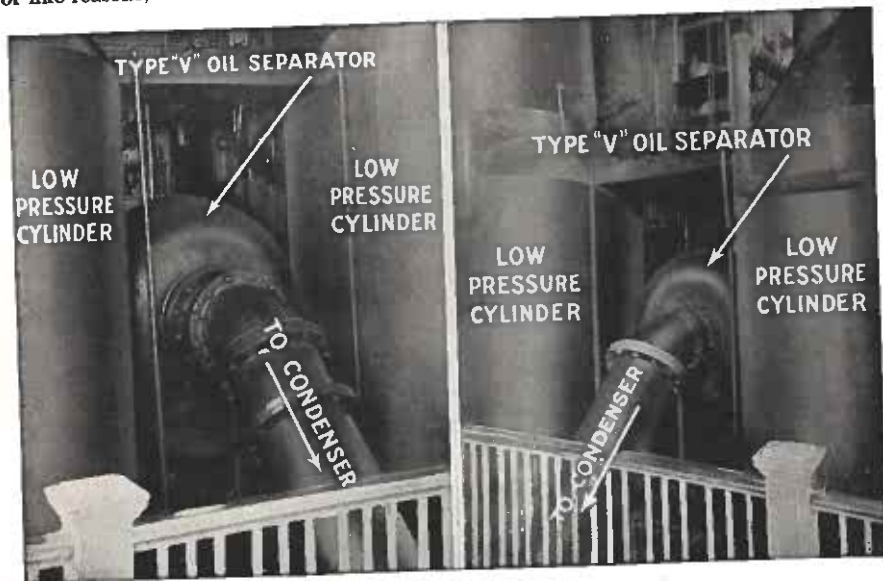

Two Wright-Austin Type "V" Vacuum Oil Separators Installed in Close Quarters Between the Low Pressure Cylinders of the Pumping Engines at the Toledo Water Works, Toledo, Ohio

TYPE "V"

Vacuum Oil Separator Self Cleaning

The illustration at the right shows a Type "V" Separator with our Special Vacuum Pump attached for drainage.

The Type "V" Separator contains all the excellent details of construction embodied in the Type "S."

It is guaranteed to extract the oil from exhaust steam operating under a vacuum, to such an extent that this steam, when condensed, will be entirely suitable for boiler feed or any other purpose for which exhaust steam condensate is used.

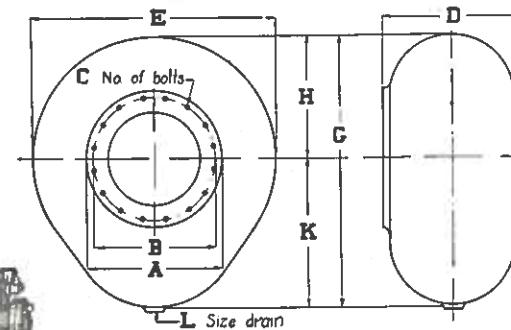
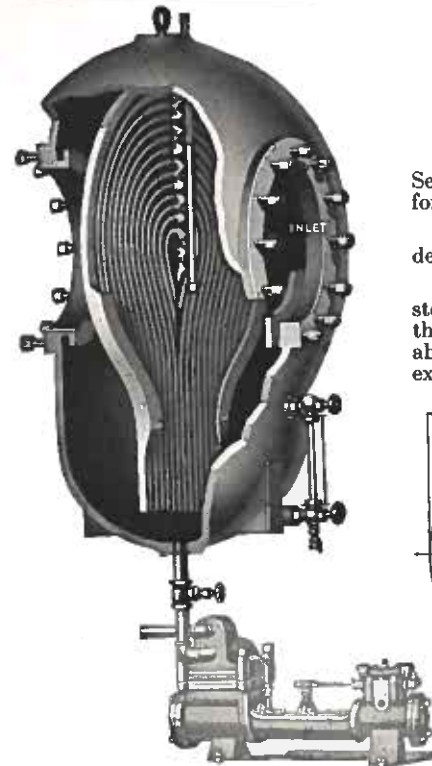

Prices and Dimensions

Pipe Size	Dimensions in Inches									Wgt. Lbs.	Code Word
	A	B	C	D	E	G	H	K	L		
8	13 1/2	11 3/4	8 - 3/4	20	34	42	17 1/2	24 1/2	1 1/2	800	Visit
10	16	14 1/4	12 - 1/8	20	36	43	18 1/2	24 1/2	1 1/2	925	Value
12	19	17	12 - 1/8	22	40	44	20 1/2	23 1/2	1 1/2	1125	Vutal
14	21	18 3/4	12-1	24	42	46	21 1/2	24 1/2	1 1/2	1375	Venal
16	23 1/2	21 1/4	16-1	26	44	49	22 1/2	26 1/2	1 1/2	1475	Verge
18	25	22 3/4	16-1 1/8	30	48	55	24 1/2	30 1/2	2	2075	Vesta
20	27 1/2	25	20-1 1/8	33	54	62	27 1/2	34 1/2	2	2500	Vicar
22	29 1/2	27 1/4	20-1 1/4	36	58	68	29 1/2	38 1/2	2	3050	Vowel
24	32	29 1/2	20-1 1/4	38	64	74	32 1/2	41 1/2	2 1/2	4000	Vixen
26	34 1/2	31 3/4	24-1 1/4	40	69	80	34 1/2	45 1/2	2 1/2	5650	Vivid
28	36 1/2	34	28-1 1/4	42	74	86	37 1/2	48 1/2	2 1/2	6000	Vigil
30	38 3/4	36	28-1 1/8	44	80	93	40 1/2	52 1/2	3	6500	Villa
34	43 3/4	38 1/2	32-1 1/2	44	90	105	45 1/2	59 1/2	3	7500	Vapor
38	48 3/4	40 1/2	32-1 1/8	48	100	116	50 1/2	65 1/2	3	8300	Vobbe
40	50 3/4	45 1/4	36-1 1/8	48	106	120	53 1/2	66 1/2	3	9500	Verse
42	53	49 1/2	36-1 1/8	48	112	129	56 1/2	72 1/2	3	10500	Vomer

Special prices on application.

Made with close flanges, and furnished with stud bolts, also eye bolts, and inside spray attachment.

When ordering or obtaining prices, be sure to give: 1—Size of Pipe Connections. 2—Maximum Pounds of Steam per Hour. 3—Maximum, Normal and Minimum Inches of Vacuum. 4—Direction of Steam Flow through Separator.

Also made of riveted steel construction for Horizontal, Vertical or Angle connections to suit conditions.

**“Standard Special”
Steel Receiver Oil Separators**
for
Low Pressure—Vacuum



One 42' and One 18' Steel Receiver Vacuum Oil Separators

Oil Separators can be built to order from Standard patterns and Standard designs, at moderate prices, to suit customer's special conditions, in the same manner that Riveted Steel Steam Separators can be built. See page 22 for general information on “Standard Special” Separators.

Welded joints can be furnished when desired. Separators are built in accordance with the A. S. M. E. Code unless otherwise specified. Their construction follows the description given on page 24.

ADVANTAGES OF OIL SEPARATORS BUILT TO ORDER

First—Complete elimination of oil at any velocity and for any volume of steam per hour.

When exhaust steam is to be returned to the boiler, used for ice making, heating systems, drying, steam cooking, etc., it is imperative that oil be entirely removed. If conditions are out of the ordinary, the only sure way to accomplish this is to build a Separator to meet the conditions.

Second—Convenient arrangement of connections to suit piping.

Third—Arrangement of volume and dimensions to suit customer's desires or engineer's designs.

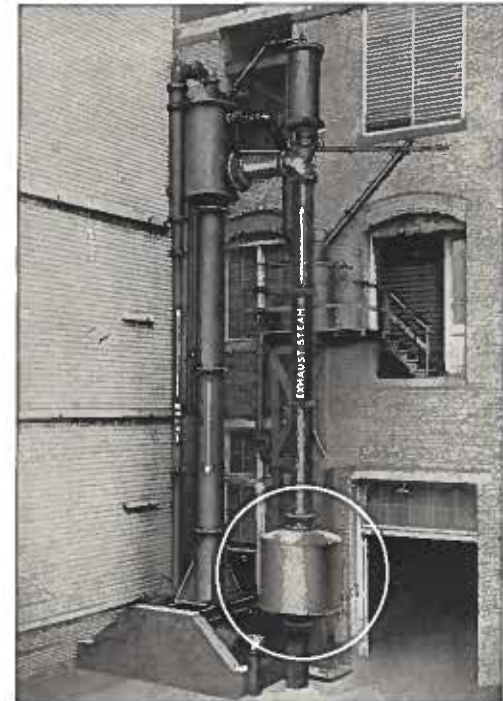

A Large “Standard Special” Vacuum Oil Separator, 8 Feet High, on Exhaust Steam Pipe between Engines and Barometric Condenser



Two 16” “Standard Special” Steel Angle Receiver Oil Separators
Furnished to Eliminate Oil and Moisture from Exhaust Steam
Before Use in 2,000 KW. Low Pressure Turbines

Horizontal Separators for Compressed Air and Gas

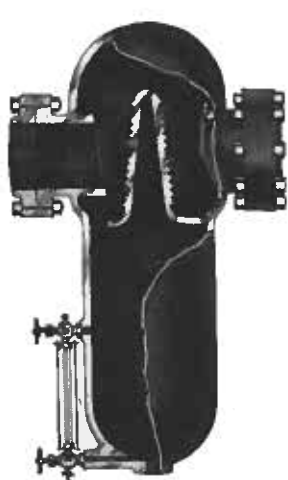

TYPE "E"
For Pressures Above 50 Lbs.



TYPE "S"
For Pressures from 0 to 50 Lbs.

Wright-Austin Type "E" and Type "S" Horizontal Separators are especially adapted for the complete extraction of oil and moisture from air or gas. The Type "E" is used with pressures above 50 lbs. per square inch, the Type "S" at pressures from 0 to 50 lbs. per square inch.

Hundreds of these Separators are in use throughout the United States on air service and, according to reports constantly received, they are giving complete satisfaction.

The selection of the Type "E" and the Type "S" Separators for use with air and gas was not a haphazard choice but the result of careful experimenting and some modification of design to make the Separators suitable for both steam and air. As a result, they are as well adapted to air and gas service as though they had been designed for these alone.

Detailed descriptions of these Separators will be found on pages 13 and 31 as well as on page 39 opposite.

The proper installation of Separators on compressed air systems has been thoroughly studied by Wright-Austin engineers. Advice as to the best size and location of Separators will be given, without obligation, to any one making inquiry or forwarding a sketch of his piping system.

These Separators are also used to extract liquid from gaseous chemicals to a considerable extent and the Wright-Austin Engineering Department will advise as to such use at any time.

TYPE "E"

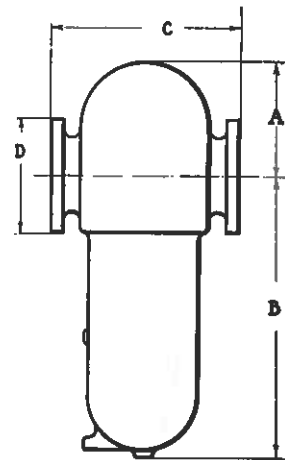

Pipe Size	Dimensions in Inches					Wgt. Lbs.	List Price Includes Water Gauge Only	Code Word
	A	B	C	D	Drain			
1 1/2	5	10	10 1/2	S. E.	1/2	60	\$26.00	Effet
2	5	10	10 1/2	S. E.	1/2	60	28.00	Exert
2 1/2	6	12	11	7	3/4	125	36.00	Erupt
3	6 1/2	13	12 3/4	7 1/2	3/4	155	43.00	Essay
3 1/2	7 1/2	15	13 3/8	8 1/2	3/4	170	54.00	Entry
4	9	17	14 3/4	9	3/4	230	66.00	Ephod
4 1/2	10	20	16 1/4	9 1/4	3/4	310	78.00	Epoch
5	11	23	19	10	1	470	108.00	Erase
6	12	26	21	11	1	565	132.00	Estop
7	13 3/4	29	22 3/4	12 1/2	1 1/4	715	168.00	Ether
8	16	32	24	13 1/2	1 1/4	880	224.00	Evict

Regularly furnished with flanges drilled to A. S. M. E. Standard Schedule for working pressures up to 125 lbs. per square inch. Can also be furnished for Extra Heavy Schedule at same price, see page 13.

Companion flanges, also drain valve and nipple, can be furnished at extra cost. For prices and flange drilling see page 40.

Carried in stock.

TYPE "S"

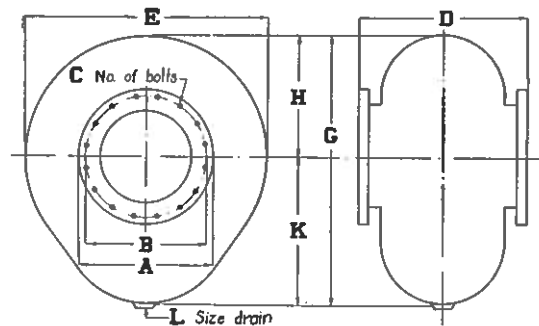

Pipe Size	Dimensions in Inches										Wgt. Lbs.	List Price	Code Word
	A	B	C	D	E	G	H	K	L				
1 1/2	Scrd.	9 7/8	12	15 1/2	6 1/8	9 3/8	3/4	60	\$24.00	Saxon	
2	Scrd.	10	12 1/8	15 1/2	6 1/8	9 3/8	3/4	70	27.00	Saury	
2 1/2	7	5 1/2	4 - 5/8	10 1/4	14 1/2	17 7/8	7 7/8	10 1/8	1	150	42.00	Skiny	
3	7 1/2	6	4 - 5/8	10 1/2	15	18	7 1/2	10 1/2	1	165	48.00	Satin	
3 1/2	8 1/2	7	4 - 5/8	11	17	20	8 1/2	11 1/2	1	190	54.00	Sandy	
4	9	7 1/2	8 - 5/8	12	19	23	9 1/2	13 1/2	1	235	72.00	Saint	
4 1/2	9 1/4	7 3/4	8 - 3/4	13	21	25	10 1/2	14 1/2	1 1/4	290	80.00	Scare	
5	10	8 1/2	8 - 3/4	15	23	27	11 1/2	15 1/2	1 1/4	370	100.00	Scene	
6	11	9 1/2	8 - 3/4	17	25	30	12 1/2	17 1/2	1 1/2	475	122.00	Scope	
7	12 1/2	10 3/4	8 - 3/4	17 1/2	27	33	13 1/2	19 1/2	1 1/2	580	156.00	Screw	
8	13 1/2	11 3/4	8 - 3/4	18	29	36	14 1/2	21 1/2	1 1/2	670	170.00	Stick	

Water gauges furnished on all sizes except 1 1/2" and 2."

Price includes water gauge only.

Companion flanges, drain valve and nipple, can be furnished at extra cost. For prices and flange drilling see page 40.

Carried in stock.

STANDARD COMPANION FLANGES

A. S. M. E. Standard Drilling Schedule, of 1928
For 125 Lbs. Working Pressure

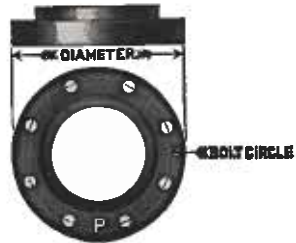

Size Inches	Diam. of Flanges Inches	Thick-ness of Flanges Inches	Dia. of Bolt Circle Inches	Number of Bolts	Dia. of Bolts Inches	Length of Bolts Inches	List Price *
1	4 1/4	7/8	3 1/8	4	1/2	1 1/2
1 1/4	4 5/8	1 1/2	3 1/2	4	1/2	1 1/2
1 1/2	5	1 5/8	3 3/8	4	1/2	1 3/4
2	6	1 5/8	4 3/4	4	5/8	2
2 1/2	7	1 1/2	5 1/2	4	5/8	2 1/4	\$3.20
3	7 1/2	3/4	6	4	5/8	2 1/4	3.70
3 1/2	8 1/2	1 1/8	7	8	5/8	2 1/2	4.40
4	9	1 1/8	7 1/2	8	5/8	2 3/4	5.70
4 1/2	9 1/4	1 1/8	7 3/4	8	3/4	2 3/4	6.30
5	10	1 1/8	8 1/2	8	3/4	2 3/4	6.70
6	11	1	9 1/2	8	3/4	3	7.80
7	12 1/2	1 1/8	10 3/4	8	3/4	3	9.80
8	13 1/2	1 1/8	11 3/4	8	3/4	3 1/4	11.70
9	15	1 1/8	13 1/4	12	3/4	3 1/4	14.70
10	16	1 1/8	14 1/4	12	7/8	3 1/2	17.00
12	19	1 1/4	17	12	7/8	3 1/2	22.50
14	21	1 3/8	18 3/4	12	1	4	30.50
15	22 1/4	1 3/8	20	16	1	4	
16	23 1/2	1 7/8	21 1/4	16	1	4	
18	25	1 7/8	22 3/4	16	1 1/8	4 1/2	
20	27 1/2	1 1/2	25	20	1 1/8	4 3/4	
22	29 1/2	1 1/2	27 1/4	20	1 1/4	5	
24	32	1 7/8	29 1/2	20	1 1/4	5 1/4	
26	34 1/4	2	31 3/4	24	1 1/4	5 1/2	
28	36 1/2	2 1/8	34	28	1 1/4	5 1/2	
30	38 3/4	2 1/8	36	28	1 1/4	5 3/4	
32	41 3/4	2 1/4	38 1/2	28	1 1/2	6 1/4	
34	43 3/4	2 1/8	40 1/2	32	1 1/2	6 1/2	
36	46	2 3/8	42 3/4	32	1 1/2	6 1/2	
38	48 3/4	2 3/8	45 1/4	32	1 5/8	6 3/4	
40	50 3/4	2 1/2	47 1/4	36	1 5/8	7	

For list price of Standard Reducing Companion Flanges add 35% to list in preceding column.

Prices on Application

*Price includes two companion flanges, bolts and nuts.
Bolt holes are drilled 1/8 inch larger than nominal diameter of bolts.
Use code word "Rodeo" if companion flanges are wanted with Separator.
Drain valve and nipple on next page.

EXTRA HEAVY COMPANION FLANGES

A. S. M. E. Extra Heavy Drilling Schedule, of 1928
For Working Pressure Up to 250 Lbs.

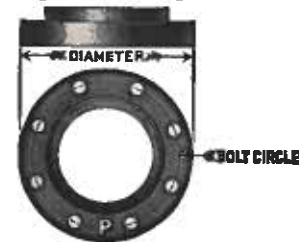

Size Inches	Diam. of Flanges Inches	Thick-ness of Flanges Inches	Dia. of Bolt Circle Inches	Number of Bolts	Dia. of Bolts Inches	Length of Bolts Inches	List Price *
1	4 7/8	1 1/8	3 1/2	4	5/8	2
1 1/4	5 1/4	3/4	3 3/8	4	5/8	2 1/4
1 1/2	6 1/8	1 1/8	4 1/2	4	3/4	2 1/2
2	6 1/2	1 1/8	5	8	5/8	2 1/2	\$4.50
2 1/2	7 1/2	1	5 7/8	8	3/4	3	5.40
3	8 1/4	1 1/8	6 5/8	8	3/4	3 1/4	6.60
3 1/2	9	1 1/8	7 1/4	8	3/4	3 1/4	8.00
4	10	1 1/4	7 7/8	8	3/4	3 1/2	9.40
4 1/2	10 1/2	1 1/8	8 1/2	8	3/4	3 1/2	9.80
5	11	1 3/8	9 1/4	8	3/4	3 3/4	10.40
6	12 1/2	1 7/8	10 5/8	12	3/4	3 3/4	13.00
7	14	1 1/2	11 7/8	12	7/8	4	16.80
8	15	1 5/8	13	12	7/8	4 1/4	19.00
9	16 1/4	1 3/4	14	12	1	4 3/4	23.80
10	17 1/2	1 7/8	15 1/4	16	1	5	33.50
12	20 1/2	2	17 3/4	16	1 1/8	5 1/4	41.70
14	23	2 1/8	20 1/4	20	1 1/8	5 1/2	55.00
15	24 1/2	2 3/8	21 1/2	20	1 1/4	5 3/4	
16	25 1/2	2 1/4	22 1/2	20	1 1/4	6	
18	28	2 3/8	24 3/4	24	1 1/4	6 1/4	
20	30 1/2	2 1/2	27	24	1 1/4	6 1/2	
22	33	2 5/8	29 1/4	24	1 1/2	7	
24	36	2 3/4	32	24	1 1/2	7 1/2	
26	38 1/4	2 1/2	34 1/2	28	1 5/8	7 3/4	
28	40 3/4	2 1/8	37	28	1 5/8	8	
30	43	3	39 1/4	28	1 3/4	8 1/4	
32	45 1/4	3 1/8	41 1/2	28	1 7/8	8 1/2	
34	47 1/2	3 3/4	43 1/2	28	1 7/8	9	
36	50	3 5/8	46	32	2	9 1/4	
38	52 1/4	3 7/8	48	32	1 7/8	9 1/4	
40	54 1/2	3 1/8	50 1/4	36	1 7/8	9 1/2	

Prices on Application

For list price of Extra Heavy Reducing Companion Flanges add 40% to list in preceding column.

Drain Valve and Nipple for Separators

Size Inches	List Price	Size Inches	List Price
1/2	\$1.60	1 1/2	\$5.00
3/4	2.00	2	7.20
1	2.80	2 1/2	13.40
1 1/4	3.70		

*See foot notes on page 40.

Wright-Austin Exhaust Heads

"CYCLONE" EXHAUST HEAD

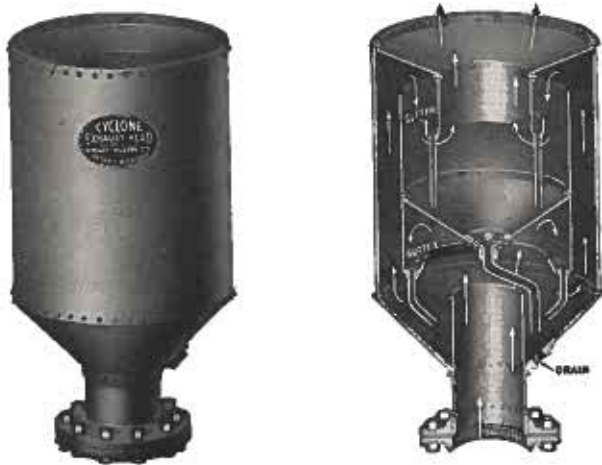

Made of Heavy Galvanized Steel, with Copper Drip Pipes Inside

Two kinds of "Cyclone" Exhaust Heads are made—Heavy Duty and Standard. Both are of the same design and differ only in dimensions and price.

The Heavy Duty is recommended where a large volume of steam is exhausted. For medium or light service the Standard is suitable.

Both are constructed of first-grade steel heavily galvanized, and provided with copper drip pipes inside that will never rust.

The steam, after being deflected by the cone, again turns, passing up between the outer and inner shells (follow the course of the arrows shown in the sectional view), and is impinged a second time against another inverted cone which forms the top. Here again provision is made to catch the condensate in a trough or gutter around the outlet pipe, and in copper drip pipes which drain it below the steam current.

In no other Exhaust Head will be found a combination of four complete reversals of the steam, double drain gutters with copper drip pipes and especially large areas and outlet, (see dimensions) slowing down the steam velocity so that it leaves this head more like the smoke from a chimney—without back pressure, absolutely noiseless and free from moisture.

Too much emphasis cannot be placed on the highly efficient and lasting qualities of the "Cyclone" Exhaust Head. It is without an equal among Exhaust Heads and will invariably outlive the plant it serves. Both Heavy Duty and Standard are fully guaranteed.

Wright-Austin Heavy Duty "Cyclone" Exhaust Head

Size of Exhaust Pipe Inches	Diam. of Outlet Inches	Outside Diam. Inches	Height Inches	Size of Drip Inches	Weight Pounds	List Price	Code Word
1	4	10	18½	½	14	\$32.00	Pagan
1½	4	10	18½	½	14	32.00	Paint
2	5	12	21	¾	19	37.00	Panel
2½	5	12	21	¾	20	37.00	Paper
3	6½	14	23¾	1	35	46.00	Party
3½	6½	14	23¾	1	42	46.00	Paste
4	8	16	26¾	1	48	54.00	Patch
4½	8	16	26¾	1	54	54.00	Peach
5	8½	18	30½	1¼	65	70.00	Pecan
6	11	21	37	1¼	80	80.00	Pedal
7	13	24	41½	1½	130	112.00	Pence
8	15	27	44½	1½	155	140.00	Peony
9	15¾	30	46¾	1½	190	165.00	Piano
10	18¾	33	52	1½	250	205.00	Piece
12	20	37	57½	2	280	270.00	Piper
14	22	42	60½	2½	355	375.00	Pitch
16	26½	46	72	2½	485	520.00	Plate
18	29	54	83	3	725	625.00	Plead
20	32	63	91	3	875	720.00	Plush

Sizes up to 2½ inches are furnished with standard thread nipples. Sizes 3 inches to 12 inches are made with flange unions. Standard flange connection can be furnished when specified. Sizes 14 inches and larger are regularly provided with a standard flange. In sizes over 20 inches the flange on the exhaust head is made to conform in diameter and drilling with the flange on the exhaust pipe.

For standard flange schedule see page 40.

Made in regular sizes up to 40 inches. Prices and details upon request. Sizes up to and including 14 inches usually in stock.

Wright-Austin Standard "Cyclone" Exhaust Head

Size of Exhaust Pipe Inches	Diam. of Outlet Inches	Outside Diam. Inches	Height Inches	Size of Drip Inches	Weight Pounds	List Price	Code Word
2	4	10	18½	½	14	\$32.00	Point
2½	4	10	18½	½	15	32.00	Poise
3	5	10	18½	½	25	35.00	Polar
3½	5	10	18½	½	28	35.00	Poppy
4	5¾	12	21¾	¾	40	44.00	Porch
4½	5¾	12	21¾	¾	45	44.00	Poser
5	6½	14	23¾	1	52	52.00	Powan
6	8	16	27	1	65	61.00	Prank
7	8½	18	31	1¼	95	80.00	Preen
8	11	21	37½	1¼	125	88.00	Prism
9	13	24	41¾	1¼	138	110.00	Proof
10	15	27	44½	1½	156	118.00	Prune
12	15¾	30	46¾	1½	180	160.00	Pulse
14	18¾	33	52½	1½	255	190.00	Punic
16	20	37	57½	2	285	254.00	Pupil
18	22	42	60½	2½	365	300.00	Purge
20	26½	46	72	2½	510	500.00	Putty

Sizes up to 3½ inches are furnished with standard thread nipples. Sizes 4 inches to 12 inches are made with flange unions. Standard flange connection can be furnished when specified. Sizes 14 inches and larger are regularly provided with a standard flange. In sizes over 20 inches the flange on the exhaust head is made to conform in diameter and drilling with the flange on the exhaust pipe.

For standard flange schedules, see page 40.

Made in regular sizes up to 40 inches. Prices and details upon request. Sizes up to and including 14 inches usually in stock.

WRIGHT-AUSTIN CAST IRON EXHAUST HEAD

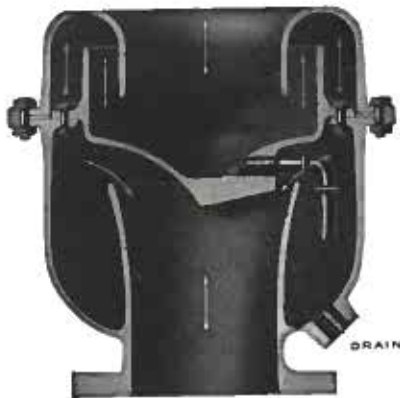

With large clearance areas and ample cooling and collecting surface, the Wright-Austin Cast Iron Exhaust Head has embodied in its design all the fundamental principles required for complete separation of oil and water from exhaust steam.

The large clearance area slows down the steam to a point where separation is possible and absolutely prevents back pressure.

Thoroughly guaranteed, and if not satisfactory in every respect, may be returned at our expense.

It is inexpensive and permanent. Costs nothing for maintenance.

Prices and Dimensions

Size Exhaust Pipe	Dimensions in Inches						Bolts No.	Weight Pounds	List Price	Code Word
	Diameter	Height	Diameter Flange	Bolt Circle	Bolts Size	Drip Pipe				
1	8	8	Scrd.	3/4	25	\$20.00	Zebra
1 1/2	8	8	"	3/4	25	20.00	Zenis
2	9	9	"	1	35	25.00	Zurra
2 1/2	9	9	"	1	35	25.00	Zenth
3	11	11	"	1	55	30.00	Ziwer
3 1/2	11	11	"	1	55	30.00	Zabie
4	12	12	"	1	65	40.00	Zoner
4 1/2	12	12	"	1	65	40.00	Zuwth
5	14	14	"	1 1/4	80	50.00	Zomba
6	16	16	11	9 1/2	3/4	1 1/4	8	120	60.00	Zutin
7	18	18	12 1/2	10 3/4	3/4	1 1/4	8	185	75.00	Zaeon
8	20	20	13 1/2	11 3/4	3/4	1 1/4	8	215	90.00	Zibbe
10	23	23	16	14 1/4	7/8	2	12	320	125.00	Zloye
12	28	28	19	17	1/8	2 1/2	12	500	150.00	Zmona
14	31	31	21	18 3/4	1	2 1/2	12	700	200.00	Zrabe

Sizes up to and including 5 inches have threaded pipe connection. Larger sizes flanged, A. S. M. E. Standard Schedule. For drilling see page 40. Carried in stock.

DRAINING STEAM AND OIL SEPARATORS

The efficiency, and even the usefulness of every Separator, depends upon the immediate removal of the moisture (and oil) collected, and the best practical method is by a good automatic Steam Trap. This automatic draining is also important, because the amount of condensation collected in a Separator varies greatly and should not be allowed to accumulate.

The Wright-Austin Company makes three types of traps suitable for draining Separators; one bucket type and one float type which apply to high pressure Steam Separators; one float type which applies to low pressure Oil Separators and is suitable for handling oil and grease. These Traps will give satisfactory service when used with the Separators for which they are intended.



The special features of the "Airxpel" Bucket Type Trap for Steam Separators are automatic elimination of air; straight line pipe connections and small weight which permits the Trap to hang on the pipe line; great accessibility to all parts; long wear requiring few repairs; and extra tight valves due to a regrinding effect.

The special features of the "Emergency" Trap are ability to handle slugs of water without choking and light loads without wire drawing. Also to operate on any pressure from 0 to 200 lbs. without change of valves or adjustments. This last feature is especially valuable on fluctuating pressures.

For handling the oil and condensation eliminated from exhaust steam by Oil Separators, the Wright-Austin "Victor" Low Pressure Oil Trap is recommended.

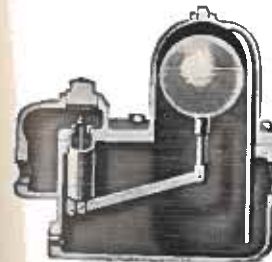

The discharge valve in this Trap is very large and opens outward away from the seat in the same direction as the outgoing oil and water, so that it will easily handle any thick, gummy oil from the Separator that will flow through the pipe.

These Traps are described in Bulletins No. 201 and No. 211, which are a part of this catalog.



SECTION II

“Airxpel” Bucket Steam Traps

BULLETIN No. 211

PAGE NUMBERS, mentioned in the text of this catalog, apply to the Section or Bulletin in which the references occur.

Wright-Austin "Airxpel" Bucket Type Steam Trap

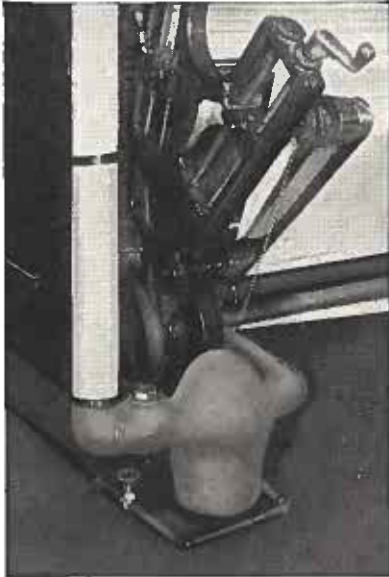

"Airxpel" Steam Trap in service at Dispatch Laundry, Detroit, for three years without removing pipe covering from trap.



The "Airxpel" Steam Trap is the result of a number of years of study, experiment, and test. The effort has been to produce a steam trap which would have as many of the advantages of existing types, with as few faults as possible, and which, at the same time, would incorporate a number of new and advantageous features.

This trap is a thoroughly tested, fully developed piece of equipment, which can be depended upon for the qualities and advantages claimed for it. It is the third member of a series of traps of which the other two members are a high pressure float trap and a low pressure float trap. These three types of traps give the user the greatest possible choice to meet any particular condition.

There are two forms of the "Airxpel" Trap, six regular or "Master" sizes from $\frac{1}{2}$ " connection to 2" connection; and two "Cub" sizes, $\frac{1}{2}$ " and $\frac{3}{4}$ " connections which are intended for installations where a very small trap is required. The regular large "Master" sizes are made in semi-steel for pressures up to 300 pounds and in cast steel for pressures up to 400 pounds. The "Cub" sizes are made for pressures up to 250 pounds.

The "Airxpel" Steam Trap embodies the following distinctive features:

Simple construction, eliminating as many moving parts as possible and making all parts strong, reliable and easily replaced. This gives long life.

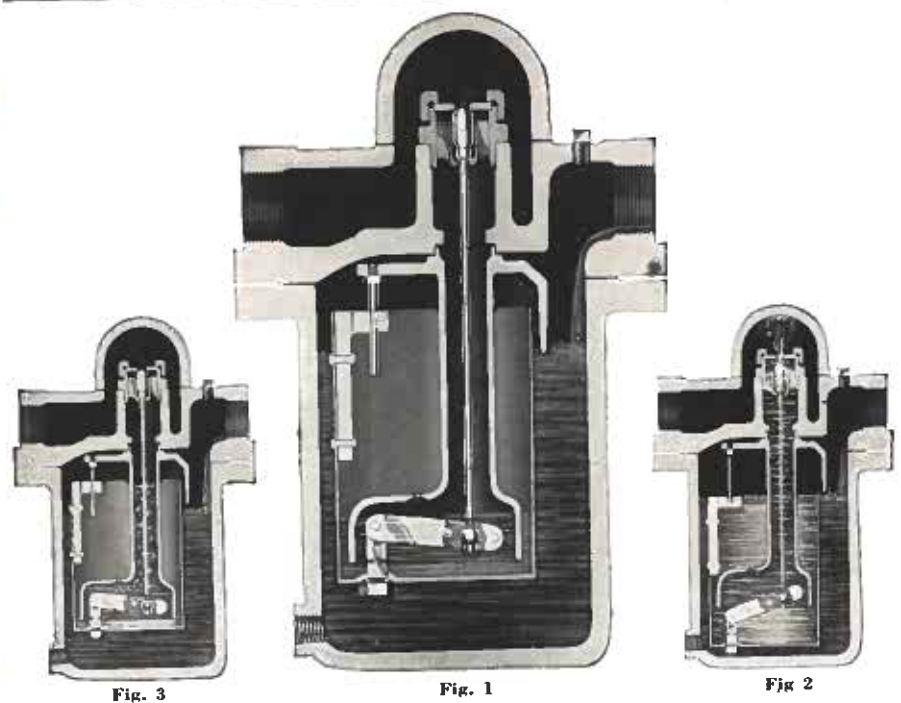

Fig. 3

Fig. 1

Fig. 2

For Low Pressures and High Pressures

Automatically expels entrained air.

The largest possible capacity for the size and cost of the trap.

Intermittent action; the valve opens instantly to full opening to discharge condensate and closes with a quick, sharp cut-off.

Complete accessibility of valve and seat by simply removing valve cap.

Small, compact size, light in weight, so the trap can be hung on the pipe line like an ordinary valve.

Straight line, horizontal pipe connections, so arranged that the trap can be easily opened without breaking any pipe joints.

Sturdy construction and material ample for pressures up to 100 pounds.

Following are special features of the "Master" sizes and do not apply to the "Cub" sizes.

Double life by having reversible double ended valve and seat of Monel Metal.

Regrinding of the valve and seat by a spirally fluted valve holder, which revolves as the trap operates, thus keeping the valve steam tight for long periods of hard service.

All details of design and construction have been worked out with the greatest care, with special attention toward multiplying the life of the valve and seat. The different sizes have been in successful operation for several years on commercial installations.

The simplicity and ruggedness of this line of traps, coupled with Monel Metal used in the valves, together with the reversibility and regrinding features, insure a very long life to the traps. There are no elaborate linkages to wear out and all material used is of the best quality.

OPERATION

Figure No. 1 shows the trap closed shortly after discharge has been completed, and before incoming condensate has started to fill the bucket.

Figure No. 2 shows the trap after the bucket has filled and dropped to open position; the trap has commenced to discharge.

Figure No. 3 shows the trap immediately after the discharge has been completed and the valve closed, but before the water has descended in the discharge tube and indicates how the air bubbles ascend the tube.

Figure No. 1 and Figure No. 2 illustrate the general operation of the trap. The condensate fills the trap and then the bucket. The buoyancy of the bucket holds the valve shut until it is overcome by condensate flowing into the bucket, after which the bucket drops and opens the valve. The pressure behind the condensate forces the contents of the bucket up the discharge tube and when it is practically all out, the bucket rises, closing the valve.

Figure No. 3 illustrates a special feature of the "Airxpel" Trap. When discharge of the condensate has taken place and the valve is closed by the rising of the bucket, the discharge tube remains full of water. The only way this water can descend into the bucket is by air finding its way into the space above it. This is what happens and the entrained air is literally sucked up into the discharge tube by the descending water seeking its level in the bottom of the bucket. When the trap discharges the next time, the air goes out first.

The air passage into the discharge tube is in the top of the horizontal portion and is just large enough to pass the air through.



Bottle Full of Water, Hole Plugged.



Air Entering Bottle, Hole Open.

If this is not entirely clear, try this experiment: put a $\frac{1}{16}$ " hole in the side of a bottle at the base of the neck, fill the bottle with water after plugging the hole and turn the bottle upside down in a pan of water, submerging the mouth of the bottle. The water will not come out. Now take the plug out of the $\frac{1}{16}$ " hole and the air will be drawn through the tiny hole into the bottle, allowing the water to flow out freely. This is what happens in the trap. The discharge tube is like the bottle, the hole is like the hole at the bottom of the discharge tube, and the air is the entrained air in the trap.

There never is any trouble with entrained air in the "Airxpel" Trap and the method of releasing air will not cause any leakage of steam.

CONSTRUCTION

The body and cover are of cast semi-steel for pressures up to 300 pounds, and of cast steel for pressures up to 400 pounds. The bucket is of copper, the valve and seat of Monel Metal, and all other parts of steam bronze.

All parts are designed for great strength, with the greatest possible simplicity and least weight.

The valve and seat are reversible, giving double life to these parts and the valve holder has spiral vanes on its side, which rotate the valve during each discharge of condensation. This keeps the valve reground and steam-tight.

The valve stem, lever and lever stem with the bucket attached constitute the entire mechanism of the trap, apart from the valve. They are the acme of simplicity, giving a valve movement which results in the trap having high capacity.

ACCESSIBILITY

The valve and seat are accessible for reversing or renewing by merely removing the hood on the top of the trap. The seat lifts out when the valve cap is unscrewed. The valve may be taken out by unscrewing the valve casing and withdrawing a pin. Both operations are very simple.

Pipe connections are straight line horizontal, connecting into the cover. The body of the trap can be removed and the bucket disconnected without breaking the pipe connections. In fact, every part of the trap is accessible, while it is still connected in the pipe line.



OTHER USES

The "Airxpel" Trap can be used successfully on compressed air systems, or with slight change to handle gasoline.

PIPE COVERING

So long is the life of the wearing parts, especially the valve and seat, and so perfectly is the air expelled that the "Airxpel" Steam Trap may be permanently insulated with pipe covering. This is valuable in conserving the heat of the condensate. (See photograph facing page 1 of this bulletin.)

"Cub" Sizes

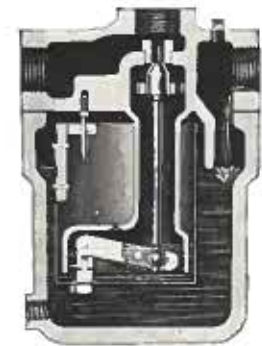

These are simpler, smaller forms of the "Master Airxpel" Trap with fewer parts but just as effective in operation and just as capable of removing entrained air. They are light in weight, though very strongly constructed, and as they hang directly in the pipe line, they can be set wherever convenient.

There is one inlet but two outlets for each trap. The first outlet is horizontal, in line with the inlet and the second outlet is vertical. In use one of these must be plugged.

These "Cub Airxpel" Traps are especially useful for steam tables and other steam cooking equipment, unit heaters, radiation, blast trap service, etc. They are made in $\frac{1}{2}$ " and $\frac{3}{4}$ " sizes, and are adapted for pressures from 0 to 250 pounds.

There are so many places where a trap is needed, in which the amount of the condensate is small, that a low priced trap like these "Cub" sizes, which are efficient and will not air bind, has a valuable position in steam trap service.

TABLE

OF DISCHARGE CAPACITIES AND DIAMETERS OF VALVE ORIFICES OF WRIGHT-AUSTIN "AIRXPEL" BUCKET TYPE STEAM TRAPS

Trap No.	Valve Dia. Inches	LBS. PER SQ. IN. MAX. DISCH. IN LBS. OF WATER PER HR. AT PRESSURES OF LBS. PER SQ. IN.															
		LBS. PER SQ. IN.															
		1	2	3	4	5	6	7	8	9	10	15	20	30	40	50	60
50	1/16	32	43	51	62	68	75	80	85	90	95	100	128	155	175	190	210
	1/8	46	67	82	95	105	115	121	132	141	150	177	220	248	280	312	340
	3/16	69	97	118	137	151	168	179	191	202	215	260	291	354	400	445	482
	1/4	123	175	212	245	273	310	325	345	365	383	460	530	635	725	800	860
	5/16	150	220	270	310	345	380	410	440	465	486	585	665	805	915	1010	1090
	3/8	198	280	345	395	445	475	510	545	575	605	735	855	1030	1165	1280	1390
	7/16	280	405	480	540	605	660	730	770	815	860	1030	1175	1420	1610	1770	1905
	1/2	365	525	630	745	830	930	1030	1090	1130	1155	1420	1660	1975	2260	2450	2630
	5/8	450	695	845	980	1085	1145	1245	1330	1405	1455	1820	2100	2530	2850	3160	3430
	3/4	620	875	1065	1235	1370	1455	1560	1660	1765	1870	2290	2630	3170	3640	3970	4320
51	7/8	790	1125	1370	1585	1760	1885	2010	2170	2250	2980	3440	4120	4680	5170	5600	
	1	1090	1520	1805	2160	2390	2520	2710	2870	3030	3210	4050	4650	5580	6350	6950	7540
	1 1/8	1500	2120	2560	2980	3290	3720	3960	4170	4480	4650	5700	6540	7780	8840	9660	10800
	1 1/4	1980	2760	3380	3900	4320	4730	5060	5350	5730	6030	7480	8620	9800	11400	12900	13410
61	1 1/2	2400	3450	4250	4920	5480	6020	6540	7060	7350	7680	9240	10550	12790	14420	16040	17380
	1 3/4	3175	4500	5480	6310	7020	7860	8150	8660	9140	9510	11430	13580	15720	17930	19800	21450
	2	4260	6120	7520	8600	9580	10500	11320	11970	12610	13530	16220	18570	22395	25500		
63	2 1/4	5795	8490	10280	11900	13250	14700	15720	16750	17800	18630	22400	25580				
	2 1/2	7850	11000	13490	15570	16280	18580	20210	21590	22970	24350	28780					
	2 3/4	9800	13980	17030	19760	22200	24600	26350	28160	29840	31300						
65	3	12970	17850	21980	25470	28430											

Lbs. per Sq. In. at the top of table refers to the first line of the table where pressures are given.

Max. Disch. in Lbs. of Water per Hr. at Pressures of Lbs. per Sq. In. refers to the quantities in the table given below the pressures.

TABLE

OF DISCHARGE CAPACITIES AND DIAMETERS OF VALVE ORIFICES OF WRIGHT-AUSTIN "AIRXPEL" BUCKET TYPE STEAM TRAPS

Trap No.	Valve Dia. Inches	LBS. PER SQ. IN. MAX. DISCH. IN LBS. OF WATER PER HR. AT PRESSURES OF LBS. PER SQ. IN.																										
		LBS. PER SQ. IN.																										
		70	80	90	100	110	120	130	140	150	160	170	180	190	200	225	250	275	300									
50	1/16	220	255	250	260	270	280	290	300	308	316	323	330	336	342	360	375	384	400									
	1/8	360	380	400	420	435	450	468	480	495	508	518	528	540	555	582	605	625	645									
	3/16	515	542	570	600	625	640	657	674	705	725	740	755	770	785	825	865	890	925	61								
	1/4	925	985	1020	1075	1120	1150	1190	1220	1265	1300	1330	1350	1370	1400	1490	1540	1580	1660									
	5/16	1470	1550	1630	1710	1775	1830	1880	1950	2020	2080	2140	2200	2260	2320	2430	2500	2660	2680									
	3/8	2030	2145	2250	2350	2440	2535	2630	2720	2810	2900	2990	3080	3140	3200	3320	3430	3530	3700	63								
	7/16	2800	2960	3130	3270	3400	3530	3640	3750	3860	3970	4060	4160	4260	4350	4550	4675	4860	5000									
	1/2	3670	3880	4075	4275	4460	4590	4750	4880	5000	5130	5260	5390	5510	5625	5950	6250	6570	6870	65								
	5/8	4580	4890	5130	5370	5600	5800	5980	6130	6300	6460	6640	6770	6960	7160	7580	8000											
	3/4	5950	6310	6640	6900	7180	7480	7690	7800	8130	8390	8560	8750	8950	9250													
51	7/8	8080	8550	9000	9460	9840	10200	10550	10880	11200	11500																	
	1	11150	11850	12500	13100	13620	14200																					
	1 1/8	14250	15080	16340	16750																							
61	1 1/4	18510	19690																									

DIRECTIONS FOR USING CAPACITY TABLE

Each size of Trap is represented by a heavy, zigzag line. The figures shown directly above any zigzag line give the capacity of the Trap the line represents. The pressure corresponding to any given capacity is shown at the top of the table and the size of valve orifice in the extreme left hand column.

EXAMPLES

1. To find the CAPACITY of No. 61 "AIRXPEL" TRAP at 160 lbs. pressure, locate 160 lbs. at top of table. Proceed down column to zigzag line representing No. 61 TRAP. The capacity of the Trap is shown above the line as 2080 lbs. per hour. The size of valve orifice is 5/8" as indicated in the left hand column.

2. To find the SIZE of TRAP required to HANDLE 5,200 lbs. water per hr. at 100 lbs. pressure, follow down the 100 lbs. pressure column until a capacity approximating 5,200 lbs. is located. The closest capacity available is 5,370, which will require a No. 63 TRAP. The size of valve orifice for this size of Trap and capacity at 100 lbs. pressure is 3/2" as shown in the left hand column.

**INSTALLATIONS OF WRIGHT-AUSTIN
"AIRXPEL" STEAM TRAP**

Besides the installations of the "Airxpel" Trap illustrated on this page, at the Detroit-Leland Hotel, Detroit, Mich., and the Equitable Office Building, New York City, also the Dispatch Laundry, Detroit, shown opposite page 1, there are hundreds of installations throughout the country.

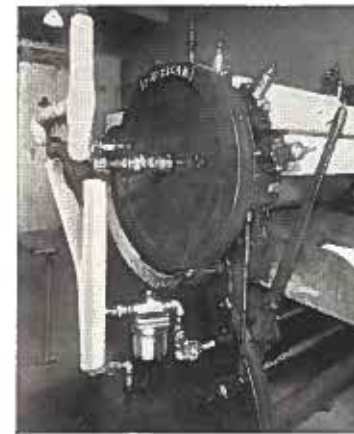

"Airxpel" Trap in Laundry at Detroit-Leland Hotel, Detroit, Mich.

A considerable number of firms are sending in repeat orders. Industries represented are widely spread, of many different types, among which we might mention power plants, heating, drying and process work, oil refineries, public buildings, laundries, dairy industry, chemical plants, packing plants, manufacturers of machinery using steam; railroads, soap factories. The list is a long and important one.

Our daily correspondence testifies to the enthusiasm with which this trap has been received, to the great satisfaction of those who are using it, to its convenience, accessibility and above all to its freedom from repairs and breakdowns.

There is no better trap on the market, of that we are sure.

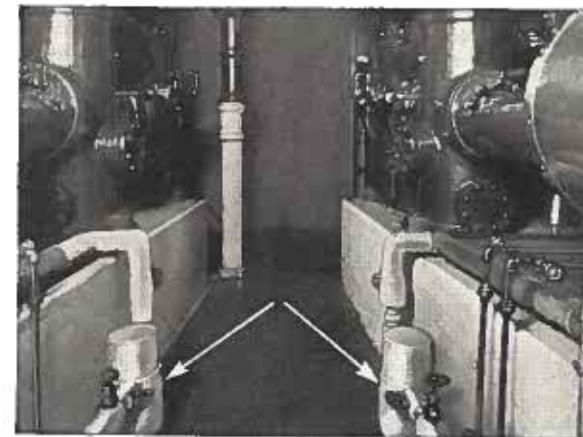

"Airxpel" Traps on Fire Pumps. Equitable Office Building, New York City

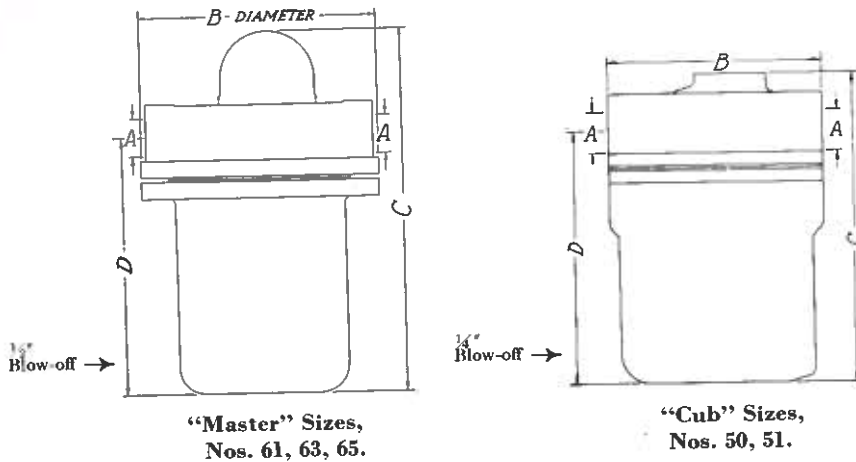

"Master" Sizes, Nos. 61, 63, 65.

"Cub" Sizes, Nos. 50, 51.

Dimensions, Weights, List Prices and Code Words

Size No.	Pipe Size of Inlet and Outlet A Inches	Max. Diameter B Inches	Height C Inches	Center Inlet and Outlet to Bottom, D Inches	Weight, Lbs.	List Price Semi-Steel Traps, Pressure to 300 Lbs.	Code Word
†50	1/2	4 5/8	7 1/4	5 3/4	10	\$11.00	Quail
†51	3/4	4 5/8	7 3/8	6	11	14.00	Queue
61	1/2 or *3/4	6 3/8	11 3/8	8	23	24.00	Quiet
63	1 or *1 1/4	8	14 3/8	9 5/8	41	42.00	Quill
65	1 1/2 or *2	9 3/4	17 7/8	12 3/4	74	80.00	Quoin
							1 1/4" Quora
							1 1/2" Qurau
							2" Qurts

†Nos. 50 and 51 are the small "Cub" sizes.

*Pipe sizes marked with asterisk furnished unless otherwise specified.

Size No.	Pipe Size of Inlet and Outlet Inches	MAXIMUM DISCHARGE IN POUNDS OF WATER PER HOUR AT PRESSURES OF											
		Semi-Steel Traps										**Cast Steel Traps	
		5 Lbs.	10 Lbs.	20 Lbs.	40 Lbs.	60 Lbs.	80 Lbs.	110 Lbs.	150 Lbs.	170 Lbs.	250 Lbs.	350 Lbs.	400 Lbs.
50	1/2	1760	2400	1660	1165	865	542	625	495	518	375
51	3/4	2390	3210	2100	1610	1090	985	1120	705	740	605
61	1/2 or 3/4	7020	7680	6540	4680	3430	2960	2440	2020	2140	1540	985	1045
63	1 or 1 1/4	9580	9510	13580	12900	7540	6310	5600	5000	4060	3430	2810	2330
65	1 1/2 or 2	28430	31300	25580	25500	21450	19690	13620	11200	8560	8000	5340	5710

**Prices furnished on application.

When ordering be sure to specify maximum working steam pressure under which each trap is to operate.

INSTALLATION AND MAINTENANCE OF "CUB" AND "MASTER" SIZES OF "AIRXPEL" BUCKET STEAM TRAP

Always set a Trap level, whether it has a support or hangs on the pipe line. Place it in as accessible a location as possible, below the lowest point to be drained wherever this can be done.

Every Trap should be provided with shut-off valves, as well as a by-pass, similar to sketch shown here. Blow-off connection to sewer is also recommended.

When steam is first turned on, open the blow-off valve for several minutes to thoroughly blow out all pipe lines. This is especially important on new pipe lines, which usually contain a large amount of grit and dirt.

After installation every Steam Trap should be blown off frequently; if possible, once a day.

A Strainer should be installed ahead of every Steam Trap except Traps used to eliminate oil and grease. A Strainer will prevent 90% of all trap troubles and greatly increase the life of the trap valves.

Installation of a Trap should be made in such a manner as to eliminate the possibility of any air pockets in the piping to the inlet of the Trap.

The "Airxpel" Trap is non-air-binding and will expel into the trap discharge all air which enters it. It has no air vent and requires none, so that it can be covered with pipe covering to retain the heat like any other part of the piping system.

Wherever possible leave a few inches free space above and below the Trap. This is not essential but if such space can be left open, it makes it possible to open the Trap completely, without taking it off the pipe line. The Trap itself is fully accessible while connected in the line.

Interchangeable valves and seats make it possible to change the pressure for which the "Airxpel" Trap is adjusted by changing the valve seat. This is easily done in a few minutes without taking the Trap off the pipe line.

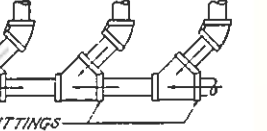

Always use "Y" connections instead of tees, as illustrated above, where two or more drains are grouped to one trap. This prevents the flow of condensation in some lines from being retarded by others discharging, as occurs when tees are used instead of "Y" fittings.

Installation of a Trap should be made in such a manner as to eliminate the possibility of any air pockets in the piping to the inlet of the Trap.

The "Airxpel" Trap is non-air-binding and will expel into the trap discharge all air which enters it. It has no air vent and requires none, so that it can be covered with pipe covering to retain the heat like any other part of the piping system.

Wherever possible leave a few inches free space above and below the Trap. This is not essential but if such space can be left open, it makes it possible to open the Trap completely, without taking it off the pipe line. The Trap itself is fully accessible while connected in the line.

Interchangeable valves and seats make it possible to change the pressure for which the "Airxpel" Trap is adjusted by changing the valve seat. This is easily done in a few minutes without taking the Trap off the pipe line.

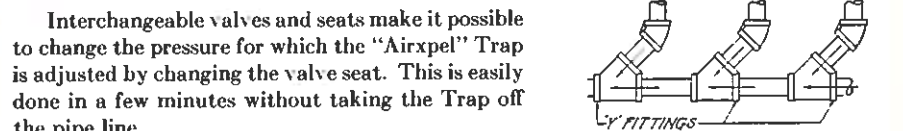

Always use "Y" connections instead of tees, as illustrated above, where two or more drains are grouped to one trap. This prevents the flow of condensation in some lines from being retarded by others discharging, as occurs when tees are used instead of "Y" fittings.

**PARTS FOR "AIRXPEL" STEAM TRAP
"Master" Sizes**

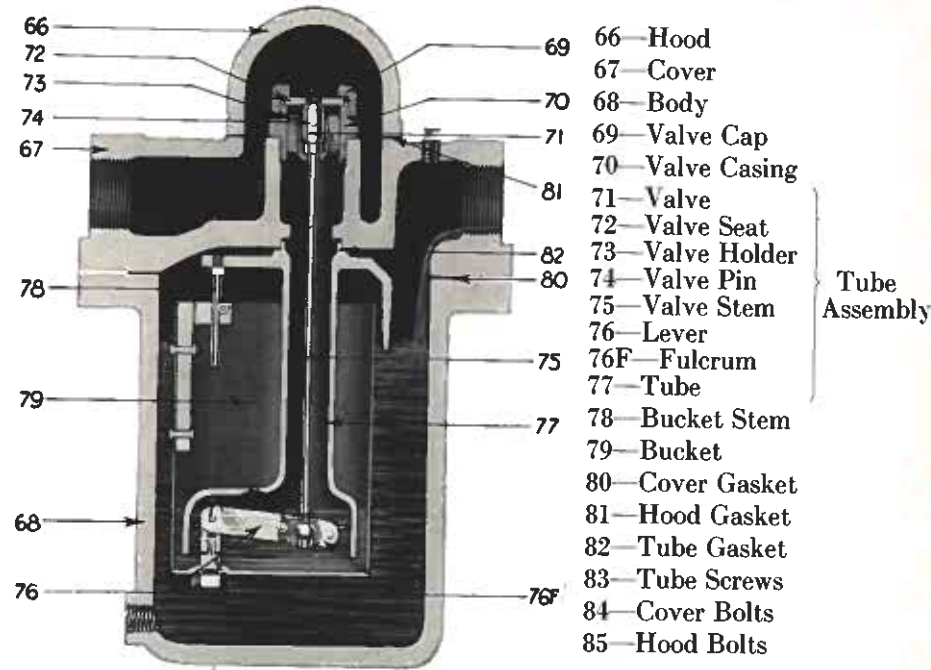

Each of the above parts can be furnished separately, or Parts 71 to 77 inclusive, the TUBE ASSEMBLY, can be furnished factory assembled, ready for insertion into the trap.

The valve and seat should always be replaced together. A new seat in an old valve or vice versa is unlikely to be a perfect fit and will result in soon wearing the new part.

In ordering be sure to give NAME and NUMBER OF PART and SIZE NUMBER OF TRAP cast on cover, also HIGHEST WORKING STEAM PRESSURE.

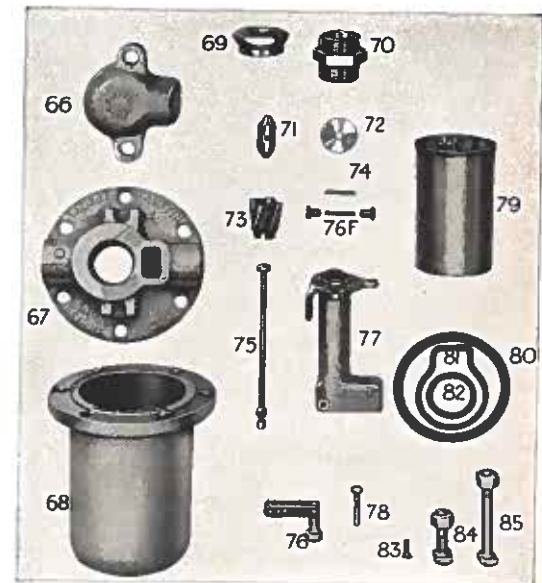

**PARTS FOR "AIRXPEL" STEAM TRAP
"Cub" Sizes**

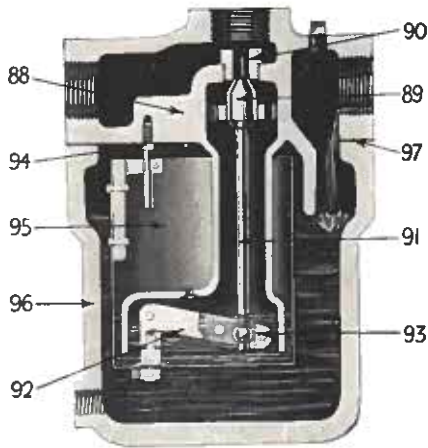

- 88—Cover and Tube
 - 89—Valve
 - 90—Valve Seat
 - 91—Valve Stem
 - 92—Lever
 - 93—Fulcrum
 - 94—Bucket Stem
 - 95—Bucket
 - 96—Body
 - 97—Gasket
 - 98—Cover Bolts
- } Tube Assembly

Each of the above parts can be furnished separately, or Parts 89 to 93 inclusive, the **TUBE ASSEMBLY**, can be furnished factory assembled, ready for insertion into the trap.

The valve and seat should always be replaced together. A new seat in an old valve or vice versa is unlikely to be a perfect fit, and will result in soon wearing the new part.

In ordering be sure to give **NAME** and **NUMBER OF PART** and **SIZE NUMBER OF TRAP** cast on cover, also **HIGHEST WORKING STEAM PRESSURE**.



SECTION III

**"Victor"-"Emergency"
Float Steam Traps
Air Eliminators
Strainers**

BULLETIN No. 201

PAGE NUMBERS, mentioned in the text of this catalog, apply to the Section or Bulletin in which the references occur.

**PARTS FOR "AIRXPEL" STEAM TRAP
"Cub" Sizes**

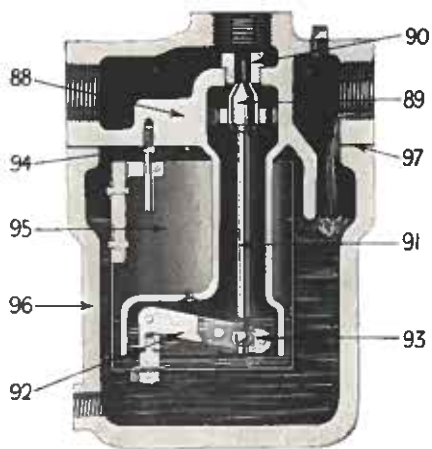

- 88—Cover and Tube
 - 89—Valve
 - 90—Valve Seat
 - 91—Valve Stem
 - 92—Lever
 - 93—Fulcrum
 - 94—Bucket Stem
 - 95—Bucket
 - 96—Body
 - 97—Gasket
 - 98—Cover Bolts
- } Tube Assembly

Each of the above parts can be furnished separately, or Parts 89 to 93 inclusive, the **TUBE ASSEMBLY**, can be furnished factory assembled, ready for insertion into the trap.

The valve and seat should always be replaced together. A new seat in an old valve or vice versa is unlikely to be a perfect fit, and will result in soon wearing the new part.

In ordering be sure to give **NAME** and **NUMBER OF PART** and **SIZE NUMBER OF TRAP** cast on cover, also **HIGHEST WORKING STEAM PRESSURE**.

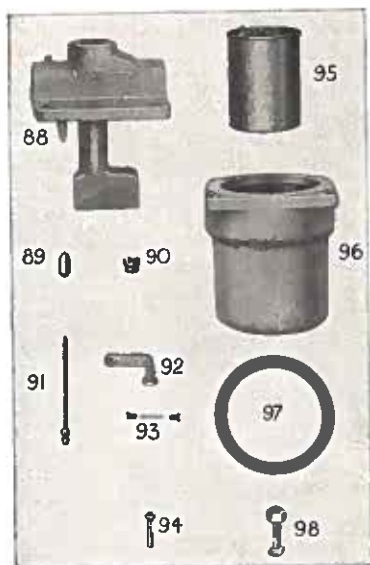

SECTION III

**"Victor"- "Emergency"
Float Steam Traps
Air Eliminators
Strainers**

BULLETIN No. 201

PAGE NUMBERS, mentioned in the text of this catalog, apply to the Section or Bulletin in which the references occur.

Wright-Austin Steam Traps



“Emergency” High Pressure Type



“Victor” Low Pressure Type

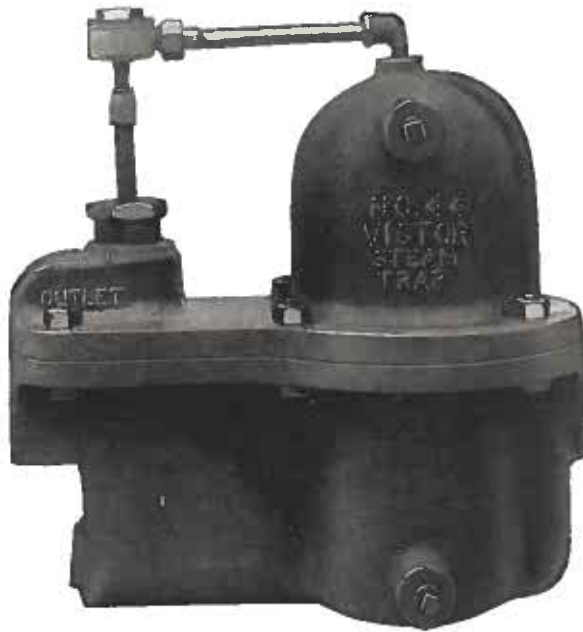

Victor Low Pressure Steam Trap for Vacuum Return Line with Thermostatic Air Vent.

THE policy of manufacturing one type of Trap and forcing it to cover all pressures was superseded by the Wright-Austin Company a long time ago. Instead, three distinct types of non-return Traps have been developed, the “Emergency” for Variable and High Pressure, the “Victor” for Low Pressure, as illustrated above, and the “Airxpel” Bucket type trap for All Pressures described in Bulletin No. 210. All three types are made in a complete range of sizes, so there is a Wright-Austin Trap to meet practically every condition, exactly as that condition should be handled. This is a unique feature of this line.

The use of a water gauge is optional, although the necessary openings are tapped in each Emergency and Victor Trap and plugged.

HOW TO BUY STEAM TRAPS

Select a high pressure type for high pressure service and a low pressure type for low pressure service (see pages 4 and 12).

For size, determine the maximum amount of condensation to be discharged at a given pressure, in accordance with tables in the back of this Bulletin, then select a size of Trap having suitable capacity to handle the condensation at that pressure. Use tables on pages 9 and 15 for the last part of the calculation.

Do not buy a Trap according to pipe size, for some Traps have only 1/25th as much capacity as others of the same pipe size. The pipe size of a Steam Trap is no more indication of its capacity than is a large pipe on a small boiler. If the capacity needed is unknown and cannot be satisfactorily calculated, then the safest way is to select the Trap having the largest capacity for the size of pipe desired.

Before purchasing make this comparison of the different Traps. Divide the net price of the Trap by the capacity of the Trap in thousands of pounds of water per hour; the result will be the cost of the Trap per unit of work, that is per one thousand pounds of water per hour.

TYPICAL GOOD INSTALLATIONS OF STEAM TRAPS

Thus $\frac{\text{Price of Trap} \times 1000 \text{ lbs.}}{\text{Capacity in lbs. per hr.}} = \frac{\text{Cost of Trap per } 1000 \text{ lbs. of water per hr.}}{\text{water per hr.}}$

Steam Traps should be figured as to cost on the basis of the amount of work done, just as boilers are sold on a horse power basis, or pumps on the basis of duty in gallons per minute. The cost per thousand pounds of water per hour is the only common unit basis of comparison by which the cost of different makes of Traps can be compared.

STEAM TRAPS AND YOUR COAL PILE

Probably no one device in all your steam plant—cost for cost—carries anything like such enormous steam saving possibilities as your Steam Trap, if given proper attention, yet it is often the most abused and neglected article about the plant. Probably no one thing so vitally affects the operation of your Steam Trap as does scale and grit from the pipe lines, yet it is amazing how few operating engineers take this problem seriously.

Thousands of Steam Traps are today connected up to important steam separators, headers, heating apparatus, cookers, etc., without as much as a shut-off valve, making it impossible to shut them off, so they get no attention, and are never cleaned out, until finally at the expense of the coal pile, they go out of business.

Many engineers think of Steam Traps as sort of rough and ready, low priced devices, and that it doesn't matter where they are located or how they are piped up. Too often they are the last pieces of equipment to be installed and are crowded down in a pit, or some inaccessible place, where it is almost impossible to get at them.

But your Steam Trap is one of the hardest working units in your entire plant. Even when most of the machinery is shut down, that little Trap is working nights and Sundays, 24 hours a day without a stop, going through thousands of operations, automatically discharging the condensation and saving the steam. Perhaps you have never thought about a Steam Trap in this way before, but it's a pretty important unit of your steam plant, isn't it?

Then make it a point to have the Trap get-at-able. Install it in a convenient and accessible place. Do not contribute to neglect by improper installation. Always have a shut-off valve on the inlet pipe, or better still have a by-pass as shown on page 17, so that you can give the Trap proper attention at any time.

Every Trap should be blown off frequently to keep it clean from dirt and scale, just as you blow off your boilers; so make it convenient to open the blow-off valve on the Trap.

The proper installation of a Steam Trap, at the lowest point to be drained, makes it the natural receptacle for all the scale and foreign matter in the entire system. Either you must blow off and clean out the Trap frequently, or stop the debris from getting into it. The latter method is preferable and most economical. A simple, inexpensive Wright-Austin Strainer on the inlet pipe to a Trap will remedy nine-tenths of all Trap ills.

Take good care of your Steam Trap. It's worth it, and will prove its worth to you by saving tons of fuel.

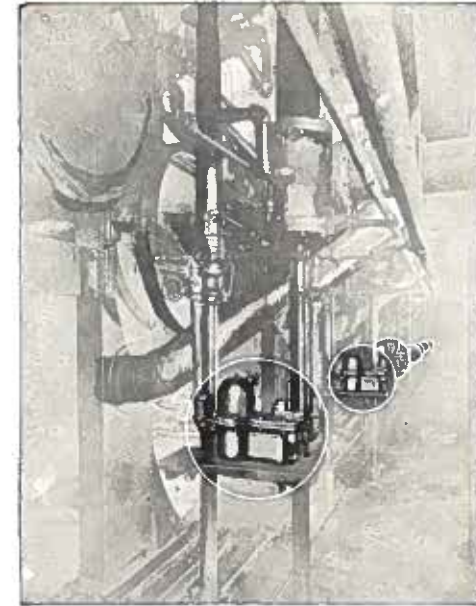

Seven Wright-Austin "Victor" Steam Traps Draining Paper Machines at the Monroe Binder Board Company, Monroe, Michigan

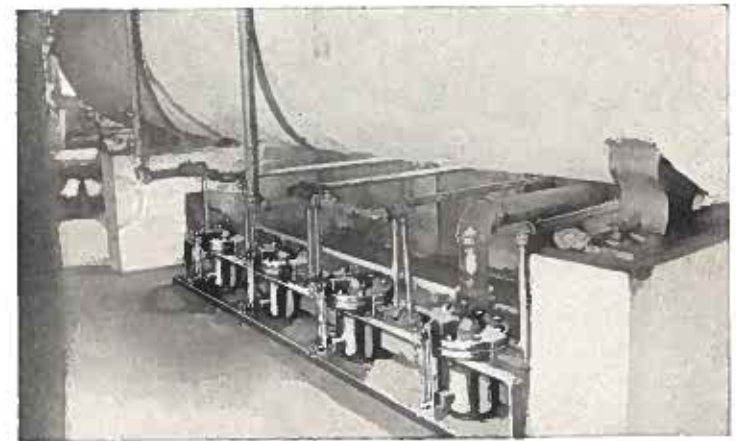

Four Wright-Austin "Emergency" Steam Traps Draining the Main Steam Header of a Large Industrial Plant

Note—The latest type of "Emergency" Steam Trap has the water gauge entirely on the body of the Trap

**THE WRIGHT-AUSTIN "EMERGENCY"
HIGH PRESSURE 3-VALVE STEAM TRAP**

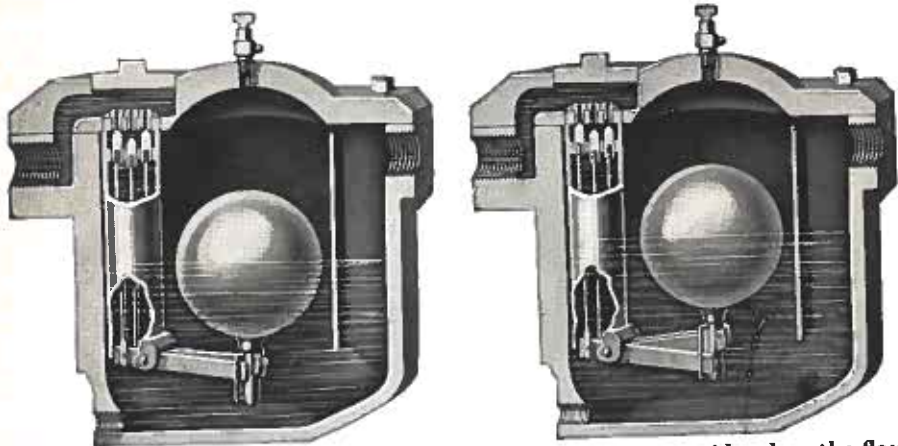

Showing position of No. 1 Valve open for normal conditions

No. 2 Valve opens wide when the flow exceeds capacity of No. 1 Valve

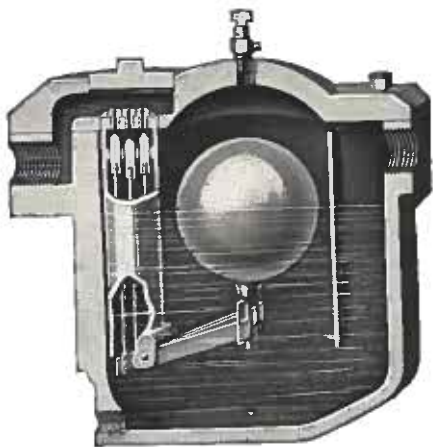

Then No. 3 Valve opens, giving full emergency capacity of Trap

THIS TRAP IS PRACTICALLY THREE TRAPS IN ONE

By each valve opening wide in turn, as needed, in One-Two-Three order, there are accomplished four great advantages in one simple, compact Trap:

- 1—Enormous discharge capacity due to the use of three valves—equal to that of three or more ordinary Traps.
- 2—Automatic regulation of the Trap to any service, heavy or light.
- 3—Almost complete elimination of throttling effect and wear on valves and seats.
- 4—Perfect adaptation for any working pressure. No change of parts or adjustments except for pressure over 200 lbs.

The Emergency Trap operates on the principle of three separate units, by putting one valve after another into service as the amount of condensation requires, each valve acting as a separate unit. Or, all three valves will instantly open wide for "Emergency" slugs or floods of condensation. When the rate of condensation decreases and the water level in the Trap recedes, the valves are closed steam tight, one at a time.

Thus, the Trap is automatically adjusted to any degree of load, and, as the amount of water every Steam Trap must handle usually varies greatly from one extreme to another, it will be seen that the three valves of the "Emergency" Traps are naturally adapted to all conditions of service by the fact that they open and close progressively.

This also has an important effect on the capacity of the Trap at different pressures. It will be observed in the table on page 9 that the CAPACITY OF THE "EMERGENCY" TRAPS INCREASE IN REGULAR PROGRESSION as the pressure is increased. This is a distinct and unique advantage as compared with a one valve Trap, because in the case of a ONE VALVE TRAP at pressures over about 75 lbs., the VALVE ORIFICE MUST BE GREATLY REDUCED to enable it to function. THIS CUTS DOWN THE CAPACITY OF MOST OTHER TYPES as much as one-half, instead of increasing the capacity as pressure is increased.

On account of the three valve design giving the "Emergency" Trap much greater capacity than ordinary Traps, it is very often possible to use an "Emergency" Trap which is smaller (measured by size of inlet and outlet) than other makes required for the same service. This is a very distinct economy in the cost of the Trap.

CONSTRUCTION



Tube Assembly. A Simple Arrangement of Stirrup, Valve Levers and Tube Containing the Valves.

The illustration at the left marked "Tube Assembly" shows the simple, inside assembly unit of all working parts except the float, with valves in a closed position.

The lever which operates the center or Number 1 valve is fastened to the stirrup and moves rigidly with the float which is attached to the top of the stirrup. The levers attached to the outside valves Number 2 and Number 3, have each some lost motion in the side slots of the stirrup, which is less in case of valve Number 2, than it is in the case of valve Number 3. As the float rises after opening valve Number 1, fastened to the stirrup, it opens valve Number 2 at a slightly later interval, due to the lost motion in the stirrup surrounding the lever connected to this valve, and at a still later interval, opens valve Number 3, through its lever and the lost motion in Number 3 portion of the stirrup. This is an exclusive feature of the Wright-Austin "Emergency" Trap which makes it practically three Traps in one.

A round seamless, strong, high pressure nickel float is used in the "Emergency" Trap. Traps are so designed that floats do not become dented,

battered or weakened by shipment, no matter how far Traps may go. All other inside parts are brass except the valves and seats which are of monel metal. The body and cover of the Trap are semi-steel of heavy design for high pressure.

MONEL METAL VALVES AND SEATS

The valves and valve seats are **GENUINE MONEL METAL**—already well known to most engineers as the toughest steam metal yet discovered for withstanding high velocities and erosion.

Furthermore, they are located in the **TOP OF THE TRAP, AWAY FROM THE SCALE AND SEDIMENT**, and by opening wide each time make a combination of three valuable features found in no other Steam Trap. This greatly increases the life and durability of the valves and seats.



Valves and Valve Seats of "Emergency" Trap—Also Shows Guide Bar for Centering Each Valve.

OPERATION

The three principal positions of the Trap in the course of operation are shown by cuts on page 4 and the details of the valves are shown in cuts on this page.

The valves are controlled by the 3-step stirrup attached to the float. Unless held open by the buoyancy of the float, the weight of the levers plus the pressure on the Trap will keep the valves closed. When each valve operates, or leaves its seat, it opens practically wide without wire drawing or throttling effect, **ALMOST ENTIRELY ELIMINATING THE WEAR ON THE VALVES AND SEATS**, and insuring steam tight valves for a longer period than any other make of Trap in similar service.

The float has a straight, direct pull on each valve to open it by means of the levers. Pressure within the Trap holds each valve tight against the seat, resisting the buoyancy of the float, until being partially submerged by the rising water, the buoyancy of the float is increased sufficiently to overcome the resistance of the pressure against the valve—and open it. The instant the valve leaves the seat, the resistance on the float is released so that it rises slightly higher in the water, thus instantly opening the valve full width, without throttling effect or cutting.

The same advantage is obtained in the closing operation. When nearly touching the seat, the steam pressure behind the valve slaps it shut quickly, practically eliminating wire drawing.

On extremely light service where there is not enough condensation to keep one valve open all the time, the valve will open and shut alternately, dis-

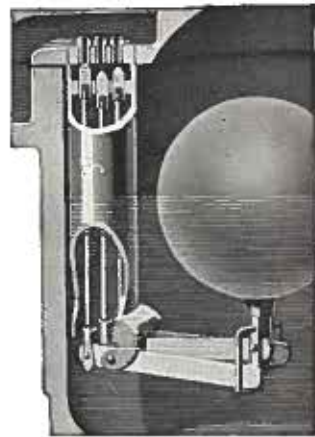

Showing Movement of 3-Step Stirrup Operating the Monel Metal Discharge Valves in One-Two-Three Order.

charging small amounts of condensation intermittently, although continuously draining the device or pipe to which it is attached. This action takes place because the valves open and close on a very small variation of the water level within the Trap.

DEEP WATER SEAL

The valves of the Trap are closed when the lower end of the discharge tube is submerged in from 4" to 7" of water—according to the size of the Trap—forming a deep and perfect water seal, which prevents any possible escape or waste of steam. (Refer to illustrations on page 4.)

ACCESSIBILITY

The inside parts are all attached to the cover and may be removed intact to the workbench or to some other light open space by simply lifting off the cover, without breaking any pipe connections. The empty body of the Trap remains in place, with pipe connections undisturbed, so that easy access is provided to the inside of the Trap for inspection and cleaning. (See illustrations on pages 4 and 17).

In addition to this the valve seats are easily reached by simply unscrewing the test plug in the cover, which is located directly over them; they may be removed with an ordinary screw driver.

NON-AIR BINDING FEATURE

The "Emergency" Trap of itself is non-air binding, and will successfully digest the air from steam separators, headers, etc., without an air vent when placed at lowest point of drainage, so that the water is not forced up to the Trap.

When draining heating systems, blast coils, or receptacles which fill with air when idle, it is advisable to use an air vent on or near the trap to facilitate quick elimination of the accumulated air from the system.

FOR COMPRESSED AIR

The "Emergency" Trap is used very successfully for draining condensation from compressed air receivers, separators, etc. See page 11 for detailed account of this service.

Whether on steam separators, heating coils, drying systems, cooking apparatus, stills or evaporators, the "Emergency" three valve Trap is 100% efficient. By continuously removing all condensation, steam is maintained at its highest temperature and the apparatus at top heat.

The one best way to tell what the Wright-Austin "Emergency" three valve Trap will do in your plant is to install it alongside of any other type in service and watch results.

**DIMENSIONS
OF WRIGHT-AUSTIN "EMERGENCY" HIGH
PRESSURE STEAM TRAPS**

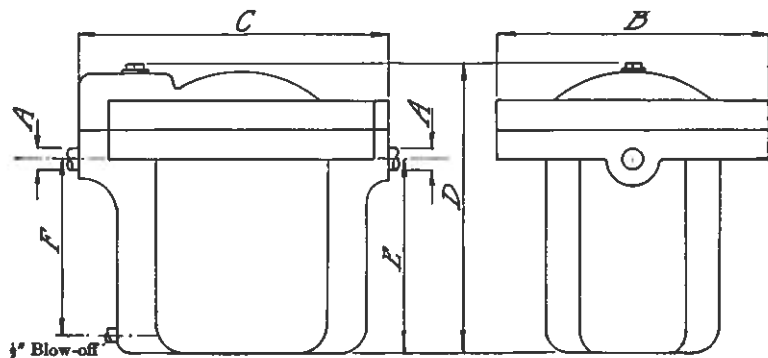

Dimensions in Inches

Size No. of Trap	A Pipe Size of Inlet and Outlet	B Diameter of Cover	C Overall Distance from Inlet to Outlet	D Height from Base to Top	E Height from Base to Connections	F Center of Blow-Off to Center of Outlet
30	1/2	7 3/4	9 1/2	9 5/8	6	4 3/4
31	3/4	7 3/4	9 1/2	9 5/8	6	4 3/4
32	1	9	11 1/4	11 7/8	7 3/4	6 1/2
33	1 1/4	10	12	12 5/8	8 3/4	7 1/4
34	1 1/2	11 1/4	12 3/4	13 3/8	9	8
35	2	11 3/4	13 3/4	13 5/8	9 3/8	8 1/4
36	2	12 3/4	15 1/4	14 5/8	10 1/8	9
37	2 1/2	14 1/4	16 1/2	16 1/4	10 3/4	10
38	2 1/2	15 1/8	18	17 3/4	11 1/2	10
39	3	16 1/2	19 1/2	19	12 1/4	10 3/4

Note—On traps No. 30 to 36 inclusive, openings (ordinarily closed with plugs) suitable for water gauge, are placed on body of Trap so that cover and all internal parts can be removed without disturbing water gauge.

USE OF TABLES ON PAGES 22 AND 23

Example: 150 feet of 4" covered pipe leads from a boiler delivering steam, containing 2 1/2% moisture, to a steam separator, and thence to an engine. The steam pressure is 150 lbs. per square inch and the velocity in the piping is 8000 feet per minute.

Wanted, the size of Trap to use for draining the separator.

Enter table No. IV on page 22, under headings 4" pipe and 150 lbs. pressure. Condensation lost per hour is 17 lbs. This times 1.5=26 lbs. Set this aside.

Enter table No. VI on page 23, under heading 4" pipe and 150 lbs. pressure. The condensation per hour is 390 lbs.

Add the first and second quantities together and multiply by factor of safety 5, to allow for slugs of water.

With the resultant figure 2080 enter the table on page 9 under 150 lbs. and read the nearest trap size, which is 3/4".

This is the Trap that should be used with the separator.

**LIST PRICES AND WEIGHTS OF
"EMERGENCY" HIGH PRESSURE STEAM TRAPS**

Size No.	Pipe Size of Inlet and Outlet	Net Weight Pounds	Boxed for Export		List Price *	Code Word
			Gross Weight Pounds	Contents of Package Cu. Ft.		
30	1/2"	35	55	1.5	\$27.00	Faced
31	3/4"	35	55	1.5	28.00	Fagot
32	1"	70	90	2.0	39.00	Fatal
33	1 1/4"	85	110	2.5	47.00	Flink
34	1 1/2"	100	125	3.0	60.00	Feign
35	2"	110	135	3.2	80.00	Fichu
36	2"	135	165	3.6	100.00	Fidge
37	2 1/2"	190	225	4.6	130.00	Firtz
38	2 1/2"	235	275	5.3	160.00	Flord
39	3"	285	330	5.8	180.00	Flake

*Price includes Air Vent.

Water Gauge, suitable for all sizes, List \$2.70—Code Word, "Fauge." Water Gauges are not furnished unless specified.

Note—Every Trap is carefully tested before shipment and fully guaranteed.

Read pages 1, 2, and 3, before selecting a Trap.

**CAPACITY OF "EMERGENCY" HIGH PRESSURE STEAM TRAPS
AT VARIOUS PRESSURES**

Size No.	Pipe Size of Inlet and Outlet	Maximum discharge in pounds of water per hour at pressures of:										
		10 Lbs.	20 Lbs.	30 Lbs.	40 Lbs.	50 Lbs.	75 Lbs.	100 Lbs.	125 Lbs.	150 Lbs.	175 Lbs.	200 Lbs.
30	1/2"	900	1160	1400	1560	1750	2000	2100	2200	2300	2400	2500
31	3/4"	900	1160	1400	1560	1750	2000	2100	2200	2300	2400	2500
32	1"	2000	2500	2900	3200	3500	4000	4400	4700	4900	5100	5300
33	1 1/4"	2400	3200	3700	4200	4500	5100	5600	6000	6300	6700	7000
34	1 1/2"	3100	4050	4800	5300	5700	6400	7100	7600	8100	8600	9000
35	2"	4000	5960	7000	7800	8400	9500	10400	11200	12000	12800	13700
36	2"	5500	7800	9300	10500	11300	13100	14400	15600	16700	17800	19000
37	2 1/2"	7000	10300	12400	13800	15000	17400	19200	20800	22400	23900	25500
38	2 1/2"	11500	16500	20200	22600	24900	29200	32500	35300	38000	40700	43500
39	3"	16100	22800	28000	31500	34800	41000	45900	49800	53700	57600	61500

For notes on the best method of installing "Emergency" Traps, see page 17.

RELATIONSHIP OF PIPE SIZE AND CAPACITY

The Wright-Austin Company continually seeks to meet actual conditions by adapting its product, from time to time, to practical power plant needs.

The No. 30 Series of "Emergency" Traps, illustrated in this catalogue was developed to meet power plant requirements more exactly than the 1 to 8 Series of "Emergency" Traps which was standard for many years and illustrated in previous catalogues.

The No. 30 Series is designed so that the cost of a Trap for a given service is made as low as possible, while at the same time the generous proportions which have always been a characteristic of Wright-Austin Traps are carefully preserved. The whole Series of "Emergency" Traps is thus designed in the interest of the user, and in accordance with a well established policy of continuous progress.

Parts for the 1 to 8 Series are carried in stock at all times.

PARTS FOR "EMERGENCY" HIGH PRESSURE TRAP

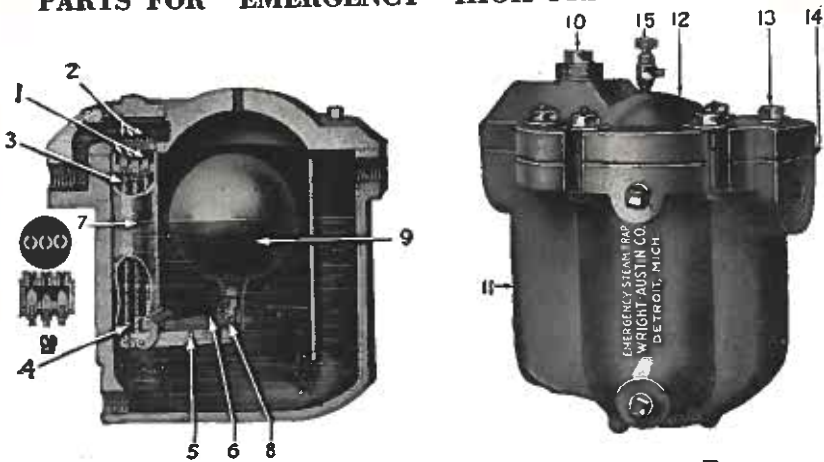

Nine Interior Parts

Six Exterior Parts

- 1—Valves
- 2—Seats
- 3—Stems
- 4—Clevises and Pins
- 5—Outside Lever
- 6—Center Lever
- 7—Tube Machined and Pins
- 8—Stirrup and Pin
- 9—Float

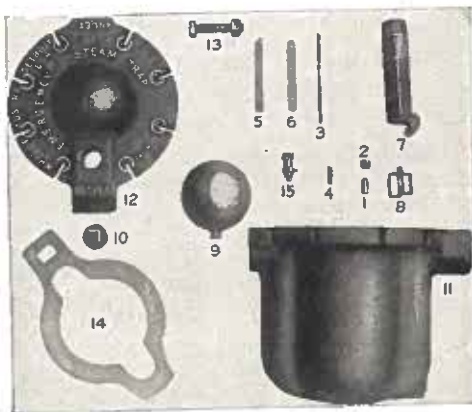

- 10—Plug (Test)
- 11—Body
- 12—Cover
- 13—Bolts and Nuts
- 14—Gasket
- 15—Air Vent

"Emergency" Traps need never be discarded, as any and all parts are interchangeable and renewable.

TUBE ASSEMBLY as shown at left, comprising parts one to eight, can be furnished factory assembled and adjusted, ready to put in service by attaching as one unit to cover and float. When more than two or three parts are desired, it is recommended the complete tube assembly be obtained. This saves the time of putting together and adjusting the parts and also makes a Trap practically as good as new. Whatever is good of the parts removed may be preserved as spares.

The valves and seats should always be replaced in pairs or complete sets. A new seat on an old valve or vice versa is unlikely to be a perfect fit, and will result in soon wearing the new part.

Separate parts can be furnished if desired.

Parts for former Trap Series No. 1 to 8 inclusive, now discontinued, can be furnished as usual.

In ordering be sure to give NAME and NUMBER of part, and SIZE NUMBER of Trap cast on cover.



"EMERGENCY" TRAPS FOR COMPRESSED AIR SERVICE

The Wright-Austin "Emergency" High Pressure Steam Trap has an unusually wide field of usefulness with compressed air.

Steam is a gas—so is air; steam is under high pressure and this is true of compressed air also; condensation occurs in both types of service, but the two services differ in some very important particulars and it is in caring for these particular features that the Wright-Austin "Emergency" excels all others.

Air lines must be kept tight or the waste measured in money is prohibitive. The "Emergency" Trap fills this requirement completely. It will stay tightly sealed when it is perfectly empty of water, whereas most Traps blow air out to the atmosphere until enough water has accumulated to form a water seal. This is a tremendous waste of valuable compressed air which the "Emergency" Trap prevents. This condition of an empty Trap is likely to occur frequently, but no air will be lost if an "Emergency" Trap is installed.

The Monel Metal valves and seats are tight and stay tight. This is described in detail on page 6 under heading "Operation."

Another way in which air lines require special consideration is in the matter of slugs of water. In the winter time when a plant is shut down for the night condensation may develop in the air lines to such an extent that considerable bodies of water will be present if it is not drained away. When the air lines are opened up for service, slugs of water start traveling through the pipes causing all sorts of unsatisfactory conditions. In addition water in cold air lines sometimes freezes and makes a great deal of trouble, and even the tools operated by compressed air may freeze and become inoperative.

The three valve construction of the "Emergency" Trap not only drains away condensation as it is formed, but takes care of slugs of water which may come traveling through the pipes due to condensation at low points. The combination of a small valve opening for light loads and a very large valve opening when slugs of water appear, is described fully on page 5, and is one of the unique features of the "Emergency" Trap. The Trap takes care of these slugs of water without the reciprocal effect of wire drawing or chattering at light loads.

The "Emergency" Trap has been in use on air lines for many years, and there are hundreds of installations giving effective service in all parts of the United States. Its upkeep on air service is practically negligible.

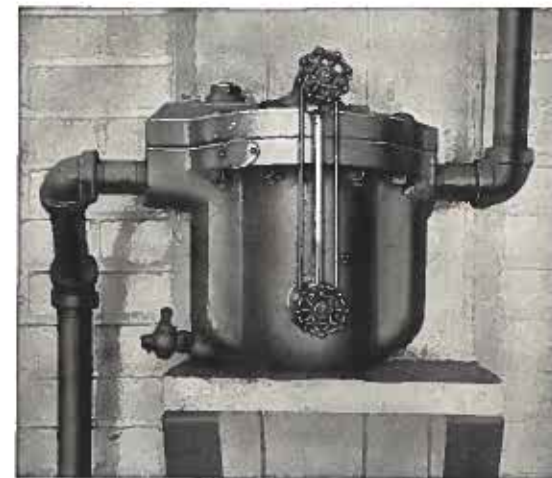

Wright-Austin "Emergency" High Pressure Trap, on Drain from Compressed Air Receiver Tank, at McGraw Ave. Plant of Kelsey-Hayes Wheel Co., Detroit, Mich. Air Pressure 125 Lbs.

WRIGHT-AUSTIN "VICTOR" LOW PRESSURE STEAM TRAP
(For pressures from 0 to 20 Lbs.)

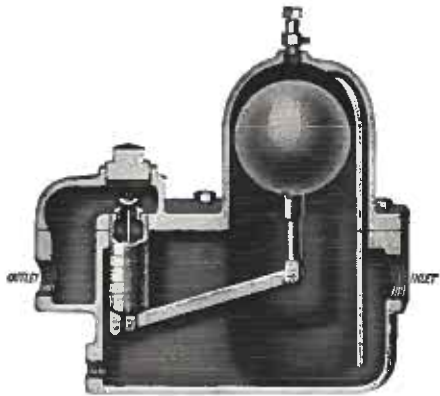

The "Victor" Trap is especially designed for low pressure service, and is not an adaptation of a high pressure Trap for low pressure work. No pressure is required to operate the "Victor" Trap. A difference of water level so slight as hardly to be measurable will operate it. It will give perfect results under any working pressure from 0 to 20 pounds.

DEPENDABILITY

Its most valuable feature is dependability, which follows as a natural result of extremely simple and rugged construction.

LARGE CAPACITY

It is especially made for draining large volumes of condensation from low pressure apparatus, such as heating systems, drying processes, hot water service heaters, coils, evaporators, etc.

This large capacity makes it often possible to install a size of "Victor" Trap (measuring size by inlet and outlet pipe diameter) which is considerably smaller, for the same service, than Traps of other makes. This results in a very distinct economy in first cost.

Incidentally, we recommend most strongly that Traps be selected on the basis of capacity in pounds of water per hour, not on the basis of pipe size; see pages 1 and 15.

OPERATION

In the "Victor" Trap the valve opens outward above the seat, and away from pressure within the Trap. Whatever pressure there may be within the Trap exerts its force underneath the valve, assisting the float to open it.

By opening the valve with the pressure (not against it, as in other Traps) and in the same direction as the outgoing flow of condensation, the "Victor" Trap becomes especially adapted for low pressure service.

This construction permits the use of a very large valve, providing enormous capacity at extremely low pressure. In operation the condensation simply overflows through the uplifted valve, freely and unobstructed.

It also serves to make the "Victor" Trap its own safety valve, as the excess pressure, whether water or steam, will force open the valve until the Trap is relieved. This is a feature of considerable importance in some installations, especially where pressure reducing valves are liable to stick open and allow pressure to build up.

DEEP WATER SEAL

Carrying a deep water seal of several inches, completely submerges the outlet tube and absolutely prevents escape or waste of any steam. See water level in cut on page 12.

CONSTRUCTION

The three working parts are attached to the cover of the Trap, which may readily be removed to the workbench, if necessary, by just lifting off the cover, without breaking any piping to the Trap.

The valve and seat are located directly under the test plug in the cover, where they can be readily inspected and tested with the cover in place. They are easily renewed by the use of ordinary tools.

MATERIALS

Only the highest grade of materials and workmanship are used in the "Victor" Traps. The valve and seat are of steam bronze, the float is copper of the finest quality; other inside parts are brass, while body and cover are semi-steel.

VACUUM SERVICE

The "Victor" Trap is admirably adapted for use on vacuum return lines. It should be installed ahead of the vacuum pump, and when used for this service, it should be furnished with an equalizing pipe connecting the dome of the trap to the plug at the outlet and this equalizing pipe should contain a thermostatic air valve.

See photograph on back cover.

Tube Assembly. All There is to the Inside Working Parts of the "Victor" Trap Except the Float.

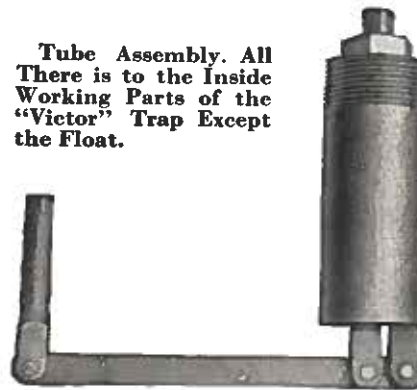

WATER REGULATOR

For a low pressure water regulator the operation of the Trap is reversed. It is changed so that the float closes the valve, as the water in the Trap rises to a pre-determined level. The Trap is installed so that the water level inside it shall correspond to the water level desired in the receptacle to which it is connected.

FOR DRAINING OIL SEPARATORS

As an Oil or Grease Trap it gives very excellent results. Because of the extremely large valve, it will easily handle any thick, gummy oil that could flow through the pipe from the separator, without choking up the Trap. A strainer is not recommended on any Oil Trap.

FOR GASOLINE SERVICE

The "Victor" Trap is used with conspicuous success when liquid gasoline is to be removed from gasoline gas. The light weight of the moving parts and the small pressure needed to operate the Trap removes the condensed gasoline easily. The liquid seal of the Trap prevents the escape of the higher volatiles.

**DIMENSIONS OF WRIGHT-AUSTIN "VICTOR"
LOW PRESSURE STEAM TRAPS**

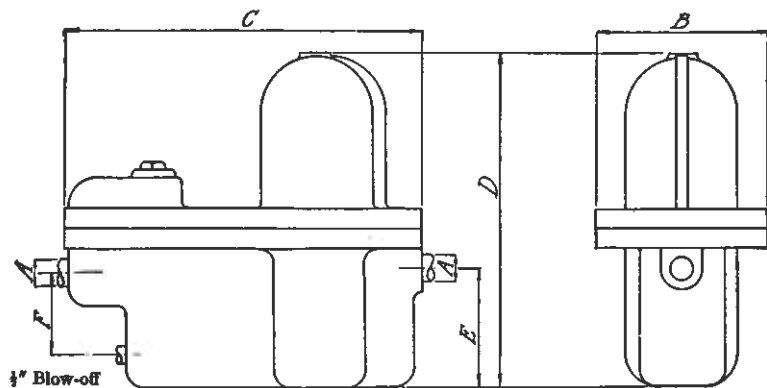

Dimensions in Inches

Size No. of Trap	A Pipe Size of Inlet and Outlet	B Width	C Overall Distance from Inlet to Outlet	D Height from Base to Top	E Height from Base to Connections	F Center of Blow-Off to Center of Outlet
40	1/2"	6 1/2"	9 5/8"	9 1/4"	4	3
41	3/4"	6 1/2"	9 5/8"	9 1/4"	4	3
42	1"	7 3/4"	12 3/4"	11 3/4"	5	4 1/8"
43	1 1/4"	8 1/2"	13 3/4"	12 3/4"	5 1/8"	4 1/8"
44	1 1/2"	9 1/2"	15 3/4"	14 1/2"	5 1/2"	4 1/8"
45	2"	10 3/4"	17 7/8"	15 1/4"	5 1/2"	4 3/8"
46	2"	11"	19 3/4"	17 3/4"	6 3/8"	5 1/8"
47	2 1/2"	12 3/4"	21 3/4"	19 1/2"	6 1/2"	5 1/4"
48	3"	14"	23 3/4"	21 1/4"	7 3/4"	6 1/8"
49	3"	14"	24"	23 1/4"	8 1/2"	7"

USE OF TABLE ON PAGE 22

Example: 20,000 feet of 2" uncovered pipe is used to heat a factory building with steam at 10 lbs. pressure. The only flow is that due to condensation.

Wanted: The size of trap to use for draining the system.

Enter Table No. V, on page 22, under 2" pipe, opposite 10 lbs. pressure and note that condensation amounts to 29 lbs. per 100 ft. per hr.

Multiply 29 lbs. by 200, the number of hundreds of feet of pipe. This equals 5800 lbs. of condensation per hour.

Enter the table on page 15, under 10 lbs. and note the trap size opposite 5800 lbs. The nearest size is a No. 42 1" "Victor" Trap but a No. 43 1 1/4" Trap would allow a better margin for unforeseen conditions.

The No. 43 1 1/4" Trap is the correct size to use.

**LIST PRICES AND WEIGHTS OF
"VICTOR" LOW PRESSURE STEAM TRAPS**

Size No.	Pipe Size of Inlet and Outlet	Net Weight Pounds	Boxed for Export		List Price *	Code Word
			Gross Weight Pounds	Contents of Package Cu. Ft.		
40	1/2"	35	55	1.5	\$27.00	Kayak
41	3/4"	35	55	1.5	28.00	Keyrt
42	1"	50	70	2.0	39.00	Kirni
43	1 1/4"	60	85	2.5	47.00	Kotto
44	1 1/2"	75	105	3.0	60.00	Kreut
45	2"	90	120	3.5	80.00	Kymog
46	2"	120	155	4.6	100.00	Krypt
47	2 1/2"	170	210	5.3	130.00	Kuklu
48	3"	200	245	6.2	160.00	Kagol
49	3"	220	275	8.3	180.00	Klapt

*Price includes Air Vent.
Water Gauge, suitable for all sizes. List \$2.70—Code Word, "Fauge." Water Gauges are not furnished unless specified. Thermostatic air valve connection all sizes, List \$9.00.
Note—Every trap carefully tested before shipment and fully guaranteed.

Read Pages 1, 2, and 3 before selecting a Trap
Select the Size of Your Trap on Capacity Basis Not by Pipe Size

**CAPACITY OF "VICTOR" LOW PRESSURE STEAM TRAPS AT
VARIOUS PRESSURES**

Size No.	Pipe Size of Inlet and Outlet	Maximum discharge in pounds of water per hour at pressures of:								
		1 Lb.	3 Lbs.	5 Lbs.	7 Lbs.	10 Lbs.	12 Lbs.	15 Lbs.	18 Lbs.	20 Lbs.
40	1/2"	1125	1945	2500	2925	3540	3825	4340	4770	5015
41	3/4"	1125	1945	2500	2925	3540	3825	4340	4770	5015
42	1"	2020	3495	4500	5250	6360	6865	7795	8565	9000
43	1 1/4"	3040	5260	6770	7900	9575	10335	11735	12890	13555
44	1 1/2"	3700	6400	8250	9620	11650	12580	14280	15690	16500
45	2"	6880	11900	15340	17885	21670	23390	26555	29170	30685
46	2"	9550	16520	21290	24830	30080	32470	36860	40490	42590
47	2 1/2"	11400	19720	25420	29640	35910	38760	44000	48335	50845
48	3"	14580	25220	32510	37900	45920	49570	56275	61820	65025
49	3"	19920	34460	44420	51790	62745	67725	76890	84460	88840

For notes on the best method of installing "Victor" Traps, see page 17.

RELATIONSHIP OF PIPE SIZE AND CAPACITY

The Wright-Austin Company continually seeks to meet actual conditions by adapting its product, from time to time, to practical power plant needs.

The No. 40 Series of "Victor" Traps, illustrated in this catalogue, was developed to meet the requirements of the heating system and other low pressure work more exactly than the 1 to 8, No. 10 or No. 20 Series of "Victor" and "Special" Traps, which were standard for many years and illustrated in previous catalogues. The No. 40 Series takes the place of the 1 to 8, No. 10 and No. 20 Series.

The No. 40 Series is designed so that the cost of a Trap for a given service is made as low as possible, while at the same time the generous proportions which have always been a characteristic of Wright-Austin Traps are carefully preserved. The whole Series of "Victor" Traps is thus designed in the interest of the user, and in accordance with a well established policy of continuous progress.

Parts for the 1 to 8, No. 10 and No. 20 Series are carried in stock at all times.

PARTS FOR "VICTOR" LOW PRESSURE TRAP

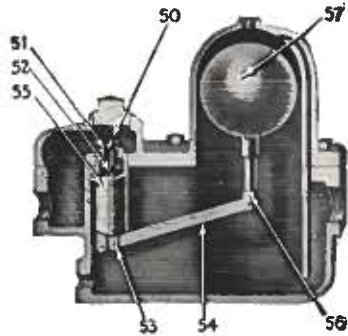

Eight Interior Parts

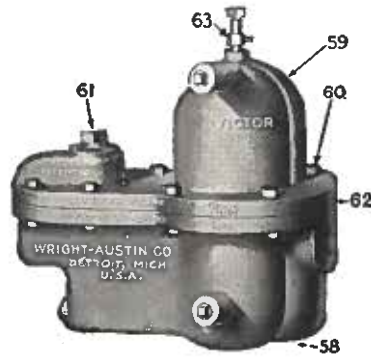

Six Exterior Parts

- 50—Valve
- 51—Seat
- 52—Stem
- 53—Clevis and Pin
- 54—Lever
- 55—Tube Machined and Pin
- 56—Swivel and Pin
- 57—Float



- 58—Body
- 59—Cover
- 60—Bolts and Nuts
- 61—Plug (Test)
- 62—Gasket
- 63—Air Vent

"Victor" Traps need never wear out as any and all parts are interchangeable and renewable.

TUBE ASSEMBLY as shown at right (comprising parts fifty to fifty-six) can be furnished factory assembled and adjusted ready to put in service by attaching as one unit to cover and float. When more than two or three parts are desired, it is recommended the complete tube assembly be obtained. This saves the time of putting together and adjusting the parts and also makes your trap practically as good as new. Whatever is good of the parts removed may be preserved as spares.

The valve and seat should always be replaced together. A new seat on an old valve or vice versa is unlikely to be a perfect fit, and will result in soon wearing the new part.

Separate parts can be furnished if desired.

Parts for former Trap Series No. 1 to 8, No. 10 to 18 and No. 20 to 28 inclusive, now discontinued, can be furnished as usual.

In ordering be sure to give NAME and NUMBER of part, and SIZE NUMBER of Trap cast on cover.

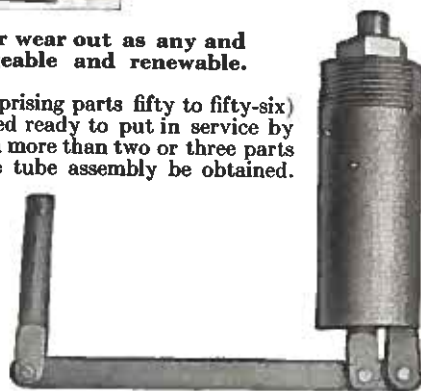

INSTALLATION

Always set a Trap level and place it in an accessible location, below the lowest point to be drained, if possible.

Every Trap should be provided with shut-off valves, as well as a by-pass, similar to sketch shown below. Blow-off connection to sewer and water gauge are also recommended.

When steam is first turned on, open the blow-off valve for several minutes, to thoroughly blow out all pipe lines. This is especially important on new pipe lines, which usually contain a large amount of grit and dirt.

After installation, every Steam Trap should be blown off frequently, if possible once a day.

A Strainer should be installed ahead of every Steam Trap, except Traps used to eliminate oil and grease. A Strainer will prevent 90% of all trap troubles and greatly increase the life of the trap valves.

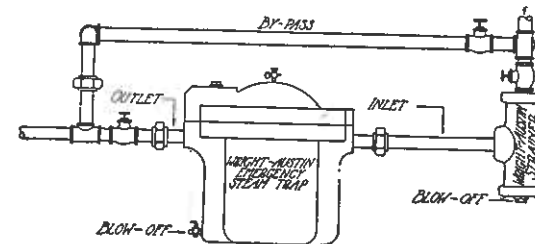

Typical Installation of "Emergency" High Pressure Steam Trap

Installation of a Trap should be made in such a manner as to eliminate the possibility of any air pockets in the piping at the inlet of the Trap.

If the apparatus drained, such as heating coils, dryers, etc., does not heat up properly, or the discharge of the condensation appears sluggish, then open the air vent on the Trap to remove accumulated air from the system until steam flows from the air vent.

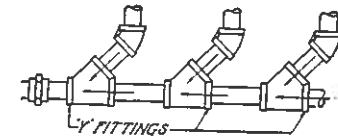

Always use "Y" connections instead of tees as illustrated above, where two or more drains are grouped to one trap. This prevents the flow of condensation in some lines from being retarded by others discharging, as occurs when tees are used instead of "Y" fittings.

A Simple Test for Possible Leaks in Valves
Should the valves of a Trap appear to leak steam, they may be tested as follows:

Close the valves at both the inlet and outlet of the Trap, to shut off all pressure, and then open the blow-off valve until the Trap is completely drained and all pressure released. Remove the test plug in the cover.

Then partly close the blow-off valve, leaving it just far enough open to drain condensation but not steam. Slowly open the valve at the inlet of the Trap, thus putting full pressure into the Trap.

If there is any leakage through the trap valves, it can be easily detected at the plug opening.

In making the above test, one should make certain that it is steam which is escaping, before deciding that the trap valves are leaking. Steam has a bluish tint, while re-evaporated condensation is white. This may be observed by opening the try-cocks on a boiler, above and below the water level.

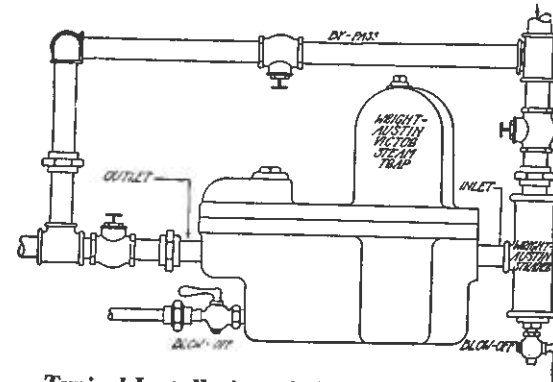

Typical Installation of "Victor" Low Pressure Steam Trap

WRIGHT- AUSTIN AIR TRAP

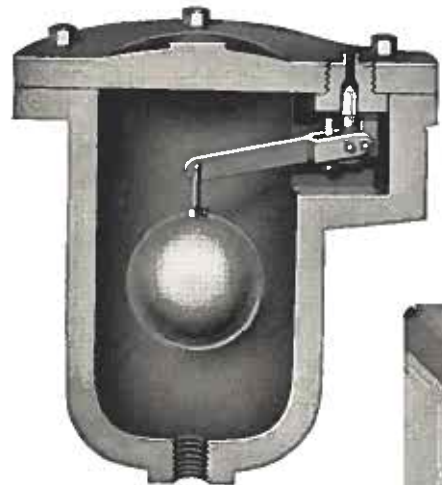

Suitable for Removing Air from Water or Other Liquid Under Pressure.

The Wright-Austin Air Trap is extensively and very successfully used on hot water heating systems, closed water tanks and receivers, water supply lines, centrifugal pumps, etc.

When desired it is furnished with a whistle for sounding an alarm when the water reaches a certain level in a tank or receiver.

It is positive in action, entirely dependable and requires no attention. It is extremely simple and well built and is fully guaranteed. It operates under any working pressure up to 150 pounds.

Dimensions in Inches

Size of Connections	Diameter	Hgt.	Wgt. Lbs.	List Price	Code Word
3/4	6	7 1/2	15	\$13.00	Urabe

Trap can be furnished tapped for 1/2" connection if desired, without extra charge.

Code Word, Ukuse.
Whistle \$1.75 additional.

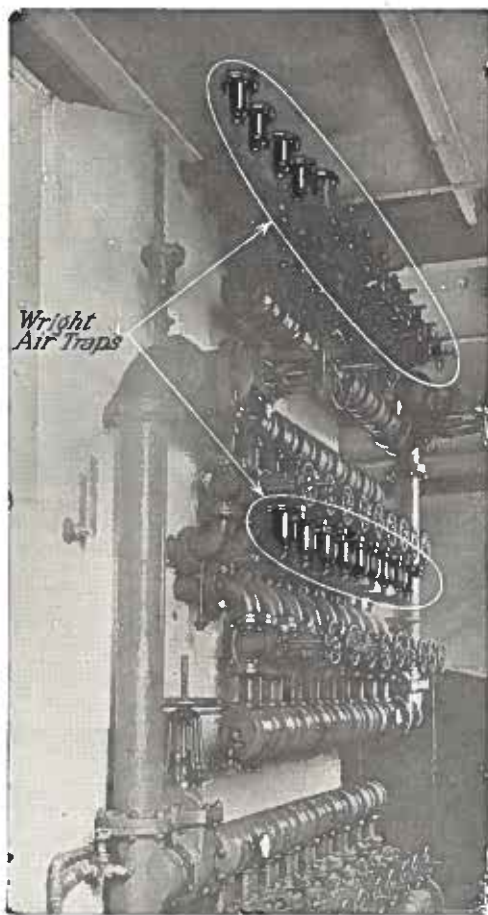

Air Traps on Oil Piping Feeding Oil Quenchers

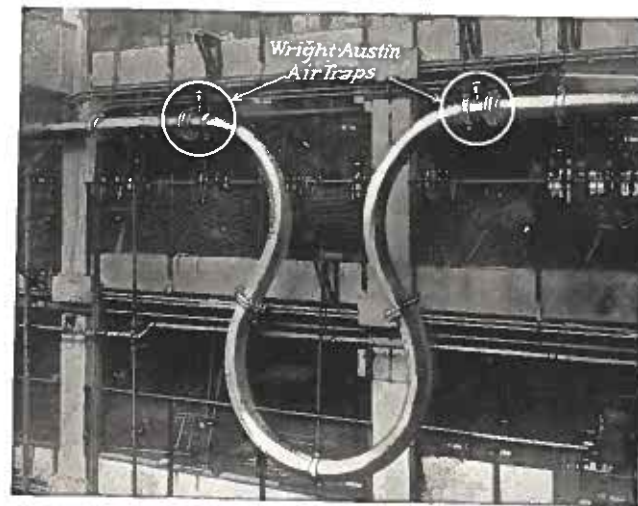

Air Traps in Use on Hot Water Heating System in Plant of Ford Motor Company, Detroit

WRIGHT-AUSTIN THERMOSTATIC AIR VALVE



This valve is of the expansion type and suitable for steam pressures up to 30 pounds. It is designed to permit the escape of air, until closed by the high temperature of steam entering the brass tube. Except for the rods, the entire valve is brass, with ample length to provide full valve opening. The valve opening may be adjusted and locked by a thumb nut.

There is nothing to crystallize or wear out, and it will give a lifetime of excellent service on traps, heating mains, receivers, etc.

Connection	3/8"
Length	11 1/4"
Weight	1 lb.
List Price	\$3.00
Code Word	Urgeb

The Air Valve illustrated here removes air from steam. The Air Trap described on page 18 removes air from liquids. Thus the whole field is covered.

The Wright-Austin Strainer for Steam, Air, Gas, Oil or Water



Stops all foreign matter, scale, packing, etc., in pipe lines from getting into Steam Traps, Pressure Reducing Valves, Oil Burners, Pumps, Heating Systems and many other devices.

By removing the gritty substances, it takes the teeth out of the steam and water that constantly gnaws away and cuts out Trap Valves, Reducing Valves, etc. Ninetenths of all Trap ills are caused by scaly grit passing into the Traps and this can positively be prevented by the WRIGHT-AUSTIN Strainer, thus eliminating the greatest source of Trap trouble.

The Strainer should be placed in the inlet pipe to every Steam Trap and Reducing Valve. It is just as effective on vacuum returns, pump suction and water supply lines.

There is no friction loss in this Strainer, as the collective area of the small holes through the large basket screen is many times greater than the area of the pipe connection, and a glance at the table shows the liberal dimensions of this strainer.

The Screen is made from finely perforated sheet brass and will never rust out.

The Strainer has top inlet and side outlet, thereby collecting all foreign matter on the inside of the screen.

As the illustration shows, the screen is cone shape, which makes the Strainer self-cleaning when blown off at the

bottom under pressure, as it thoroughly scrubs the inside of the screen clean of all debris. It is all done in an instant by using a simple blow-off valve screwed into the bottom of the plug. Or, the screen may be removed by simply unscrewing the plug to which it is attached, the dirt shaken out and screen replaced.

The Strainer is as easy to install as an ordinary ell in the pipe line. It is simple, practical, durable, and there is nothing to get out of order. The price is very reasonable, and it will pay for itself in a short time.

If desired one will be sent on approval.

DIMENSIONS AND PRICE LIST

All Dimensions in Inches

Size No.	Inlet Outlet	Dimensions						Wgt. Lbs.	List Price	Code Word
		A	B	C	D	E	F			
1	1/2	1/2	3 3/4	3	2 5/8	2	7	\$1.00	Twine	
2	3/4	1/2	3 3/4	3	2 5/8	2	7	4.00	Tefon	
3	1	1/2	3 3/4	3	2 5/8	2	7	4.00	Tefom	
4	1 1/4	1/2	3 3/4	3	2 5/8	2	7	5.00	Tabin	
5	1 1/2	1/2	4 1/4	3 1/2	2 5/8	2	12	8.00	Tilew	
6	2	3/4	5 1/4	4 3/8	4 1/8	2 7/8	20	11.00	Tharp	
7	2 1/2	3/4	6 1/4	5	4 1/8	3 1/8	28	15.00	Trime	
8	3	3/4	7 1/2	6	5	3 5/8	50	19.00	Twed	
9	4	3/4	9 1/4	7 3/4	7 3/8	5	100	30.00	Tulip	
9F	4	I	8 7/8	7 1/2	7 1/2	6 3/8	150	40.00	Trick	

No. 9F has flanged connections faced and drilled to A. S. M. E. Extra Heavy Schedule; can also be supplied with flanges faced and drilled to 125 lb. Standard Schedule if especially ordered, at same price as the Extra Heavy.

Suitable for all pressures up to 250 lbs.

Standard screens 400 holes per square inch. Any mesh screen can be made on special order.

Steel screens suitable for use with ammonia can be provided when desired.

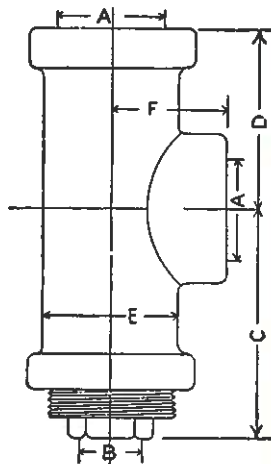

Tables

TABLE I

Table for Converting Lineal Feet of Pipe to Square Feet of Surface

Lineal Ft. of Pipe Equivalent to 1 Sq. Ft. of Surface	Pipe Size	Sq. Ft. of Surface Equivalent to 1 Lineal Ft. of Pipe
3.63	3/4"	.275
2.90	1"	.345
2.30	1 1/4"	.435
2.01	1 1/2"	.497
1.608	2"	.622
1.329	2 1/2"	.752
1.090	3"	.917
.955	3 1/2"	1.046
.848	4"	1.179
.763	4 1/2"	1.310
.685	5"	1.459
.576	6"	1.735
.501	7"	1.995
.442	8"	2.27
.397	9"	2.52
.355	10"	2.82

TABLE II

Comparative Carrying Capacities of Different Sizes of Pipe

EXAMPLE: To get size pipe to serve a 1" pipe and a 1 1/4" pipe
 1" equals 10
 1 1/4" equals 20
 30 equals 1 1/2" pipe

Dia. Pipe	Capacity Factor
1 1/2"	2
3/4"	5
1"	10
1 1/4"	20
1 1/2"	30
2"	60
2 1/2"	110
3"	175
3 1/2"	260
4"	380
5"	650
6"	1050
7"	1600
8"	2250

TABLE III

Standard Dimensions of Wrought-Iron Welded Pipe

Nominal Internal Inches	Diameter			Circumference		Transverse Areas			Length of Pipe Containing One Cubic Foot	Nominal Weight per Foot Pounds	No. of Threads per inch of Screw
	Actual External Inches	Approximate Internal Diam. Inches	Nominal Thickness Inches	External Inches	Internal Inches	External Sq. Ins.	Internal Sq. Ins.	Metal Sq. Ins.			
1/8	.405	.269	.068	1.272	.845	.129	.0568	.0720	2533.8	.244	27
1/4	.540	.364	.088	1.696	1.144	.229	.1041	.1249	1383.8	.424	18
3/8	.675	.493	.091	2.121	1.549	.358	.1909	.1669	754.36	.567	18
1/2	.840	.622	.109	2.639	1.954	.554	.3039	.2503	473.91	.850	14
3/4	1.050	.824	.113	3.299	2.589	.866	.5333	.3327	270.03	1.130	14
1	1.315	1.049	.133	4.131	3.296	1.358	.8640	.4940	166.62	1.678	11 1/2
1 1/4	1.660	1.380	.140	5.215	4.335	2.164	1.495	.6685	96.28	2.272	11 1/2
1 1/2	1.900	1.610	.145	5.969	5.058	2.835	2.036	.7995	70.75	2.717	11 1/2
2	2.375	2.067	.154	7.461	6.494	4.430	3.355	1.075	42.91	3.652	11 1/2
2 1/2	2.875	2.469	.203	9.032	7.757	6.492	4.788	1.704	30.08	5.793	8
3	3.500	3.068	.216	10.996	9.638	9.621	7.393	2.228	19.48	7.575	8
3 1/2	4.000	3.548	.226	12.566	11.146	12.566	9.886	2.680	14.57	9.109	8
4	4.500	4.026	.237	14.137	12.648	15.904	12.730	3.174	11.31	10.790	8
4 1/2	5.000	4.506	.247	15.708	14.156	19.635	15.947	3.688	9.03	12.538	8
5	5.563	5.047	.258	17.477	15.856	24.306	20.006	4.300	7.20	14.617	8
6	6.625	6.065	.280	20.813	19.054	34.472	28.891	5.581	4.98	18.974	8
7	7.625	7.023	.301	23.955	22.063	45.664	38.738	6.926	3.72	23.544	8
8	8.625	7.981	.322	27.096	25.073	58.426	50.027	8.399	2.88	28.554	8
9	9.625	8.941	.342	30.238	28.089	72.760	62.786	9.974	2.29	33.907	8
10	10.750	10.020	.365	33.772	31.479	90.763	78.855	11.908	1.83	40.483	8
11	11.750	11.000	.375	36.914	34.558	108.434	95.033	13.401	1.51	45.557	8
12	12.750	12.000	.375	40.055	37.699	127.676	113.097	14.579	1.27	49.562	8

From Standard Authorities—Not Guaranteed

TABLE IV

**Condensation in 100 Feet of Covered Pipe
in Pounds of Water per Hour**

Figured for Pipe Insulated with 2" Thickness of 85% Magnesia Covering

Gauge Pressure in Lbs. per Sq. In.	Diameter of Pipe to Be Drained in Inches											
	¾	1	1½	2	2½	3	4	5	6	8	10	12
1	2	3	3	4	4	5	6	7	8	11	13	15
2	2	3	3	4	4	5	6	7	8	11	13	15
3	2	3	3	4	4	5	6	7	9	11	14	15
4	2	3	3	4	4	5	6	7	9	12	14	16
5	2	3	3	4	4	5	6	7	10	12	14	17
6	2	3	3	4	4	5	6	8	10	12	15	17
8	2	3	3	4	4	5	6	9	11	13	15	18
10	2	3	3	4	4	5	8	10	12	15	18	21
20	3	3	4	5	5	7	9	11	13	16	20	24
30	3	4	4	5	6	8	10	12	14	18	22	26
40	4	4	5	6	7	9	11	13	16	19	24	28
50	4	4	5	6	7	9	12	14	17	21	26	30
60	4	4	5	6	7	8	10	13	15	18	22	27
70	4	4	5	6	7	8	11	13	16	19	23	29
80	4	5	5	6	7	8	11	14	17	19	24	30
90	5	5	6	7	8	9	12	15	18	20	25	31
100	5	5	6	7	8	9	12	15	18	20	25	31
125	5	6	6	7	8	9	12	16	19	22	28	35
150	6	6	6	8	9	10	14	17	21	24	31	38
175	6	6	6	8	9	10	15	18	22	26	33	41
200	6	7	8	9	10	11	15	19	24	28	35	44

This table and the one immediately below have been computed from tables of heat loss in covered and uncovered pipe at room temperature, given in the 1923 edition of Kent's Mechanical Handbook, pages 634 and 638.

The table for covered pipe has been corrected for heat loss due to friction, the velocity of the steam being taken at 8000 feet per minute, and the loss being figured for three-inch diameter pipe and over. The formula used was that given in the 1905 edition of Kent, page 671.

The table for uncovered pipe has not been corrected for friction losses, because the loss due to friction, at steam velocities ordinarily used in uncovered pipe, is a negligible percentage of the loss due to radiation.

TABLE V

**Condensation in 100 Feet of Uncovered Pipe
in Pounds of Water per Hour**

Gauge Pressure in Lbs. per Sq. In.	Diameter of Pipe to Be Drained in Inches											
	¾	1	1½	2	2½	3*	4	5	6	8	10	12
1	11	15	21	24	30	38	46	55	61	85	102	120
2	13	15	21	25	31	39	47	56	62	86	104	123
3	13	16	21	25	31	40	47	57	64	88	106	125
4	14	16	22	26	32	40	48	59	66	89	108	127
6	14	16	23	27	33	41	49	60	69	92	111	132
8	15	17	23	27	34	43	51	62	72	95	115	136
10	15	18	24	29	36	44	53	64	75	97	117	141
20	16	20	28	33	41	50	61	74	89	112	135	161
30	18	23	33	38	46	56	68	83	101	125	152	181
40	20	25	36	42	51	61	76	91	112	138	169	200
50	22	27	39	46	55	66	83	100	121	150	186	221
60	23	29	41	51	59	71	90	107	129	165	202	238
70	25	31	44	53	63	75	96	115	137	174	217	256
80	27	32	46	56	67	80	101	121	144	185	229	270
90	28	34	48	59	70	83	106	127	150	194	240	283
100	29	35	50	61	73	86	111	132	158	202	250	297
125	32	39	55	68	81	94	123	146	174	224	278	330
150	35	42	60	74	88	103	133	159	188	244	301	359
175	38	46	64	78	93	111	143	171	202	261	324	389
200	40	49	69	81	97	119	150	181	217	276	347	417

*Figures in bold face type in column headed "3 inches" may be used for the condensation in 100 square feet of heating surface.

When pipes are used in kilns for drying lumber, brick or similar substances, multiply condensation given in Table V by 6.

From Standard Authorities—Not Guaranteed

TABLE VI

**Moisture in Steam Pipe Carried Over from Boilers or
Other Source of Steam**

Table is Figured for 2½% Moisture, and Velocity of 8000 Ft. per Minute
Moisture is Given in Pounds of Condensation per Hour

Gauge Pressure in Lbs. per Sq. In.	Diameter of Pipe to be Drained in Inches													
	¾	1	1½	2	2½	3	4	5	6	8	10	12		
1	2	2	2	6	13	18	25	43	68	100	173	270	388	
2	2	2	2	6	13	18	28	45	73	105	180	285	410	
3	2	3	3	8	13	18	28	48	78	110	193	300	433	
4	2	3	3	8	13	20	30	50	80	115	203	318	455	
6	3	4	4	10	15	20	33	58	88	128	233	348	500	
8	3	4	4	10	15	23	35	63	98	140	245	380	545	
10	3	5	5	10	18	25	38	68	98	150	260	410	590	
20	4	6	6	15	25	35	53	80	115	180	260	453	713	1025
30	4	8	8	18	30	43	68	115	143	210	358	563	808	
40	5	10	10	23	38	53	80	140	180	260	453	713	1025	
50	6	10	10	25	43	60	95	160	218	315	548	860	1235	
60	7	13	13	30	50	70	108	163	255	370	640	1008	1445	
70	8	15	15	33	55	78	123	185	293	423	733	1153	1653	
80	10	15	15	38	60	88	135	210	328	475	823	1295	1860	
90	10	18	18	40	68	95	148	233	365	525	913	1435	2063	
100	13	20	20	45	73	105	163	255	400	578	1005	1580	2265	
125	15	23	23	53	88	125	195	278	435	630	1093	1718	2468	
150	15	25	25	63	103	145	228	333	523	758	1313	2065	2963	
175	18	30	30	70	118	168	258	390	613	885	1533	2413	3463	
200	20	35	35	80	133	188	290	445	698	1010	1750	2750	3950	4438

From Standard Authorities—Not Guaranteed

This table has been computed for 2½% moisture, and 8000 feet per minute velocity of steam, because these are average, normal conditions in steam power piping. To compute moisture for other than 2½%, divide the condensation given by 2½, and multiply by the required percentage of moisture. Similarly, to convert to another velocity, divide by 8000 and multiply by the required velocity in feet per minute.

The formula upon which the table is based is: C=60AVWP where C = condensation in lbs. per hour; A = internal area of pipe in sq. ft.; V = velocity in ft. per min.; W = weight of one cu. ft. of steam at the given pressure and P = the percentage moisture in the steam.

THE FIGURES IN THIS TABLE SHOULD BE MULTIPLIED BY A FACTOR OF SAFETY OF 5, to allow for slugs of water, when the table is used to determine the correct size of Steam Traps to handle condensation. This figure is the result of many years of practical experience with drainage design on the part of the Wright-Austin Company.

USE OF TABLES

Table IV, applying to condensation in covered pipe, and Table VI, applying to moisture brought over with steam, are primarily for high pressure, power piping, involving the use of Wright-Austin "Emergency" Traps. Table V, applying to condensation in uncovered pipe, is primarily for heating and other low pressure work involving the use of the Wright-Austin "Victor" Trap.

To determine the size of trap needed to handle condensation for a section of power piping, enter Table IV under the proper pipe size and pressure and multiply the condensation given, by the number of hundreds of feet of pipe. Set this quantity aside, and, as a separate operation, enter Table VI under the proper pipe size and pressure to find the condensation due to moisture. Under normal conditions no correction should be made to the amount of condensation given in the table, but if the velocity of steam and percentage of moisture is known BY TEST to be different from 8000 ft. per minute, and 2½% respectively, correction can be applied in accordance with the note under Table VI.

Add the figures obtained from Tables IV and VI and multiply by FIVE. With the resultant figure, enter the table of Trap Capacities on page 9 (or in rare cases of power plant piping, that on page 15) under the proper pressure, and from this read the size of trap suitable for draining the piping in question. This will also be the size of trap suitable for draining any separator or receiver which may be included in the piping.

In the case of radiation from bare piping, where slugs of water do not occur, enter Table V under the proper pipe size and pressure. Multiply the condensation by the number of hundreds of feet of pipe. The resultant figure should then be used to enter the table of Trap Capacities on page 15 (or in rare cases above 20-lb. pressure, that on page 9) under the proper pressure. The correct size of trap to use can then be read from the table.

In cases of radiation from flat surfaces, the size of trap needed can be obtained by using the figures in Table V under 3-in. pipe, as condensation from 100 sq. ft. of flat surface. Proceed as for pipe surface in making further calculations.

An example of figuring for power plant piping will be found on page 8.

TABLE VII
Decimal Equivalents
 By 64's from $\frac{1}{64}$ to 1 Inch

Fraction	Decimal	Fraction	Decimal	Fraction	Decimal	Fraction	Decimal
$\frac{1}{64}$.015625	$\frac{1}{32}$.265625	$\frac{1}{8}$.515625	$\frac{49}{64}$.765625
$\frac{2}{64}$.031250	$\frac{3}{32}$.281250	$\frac{9}{64}$.531250	$\frac{50}{64}$.781250
$\frac{3}{64}$.046875	$\frac{4}{32}$.296875	$\frac{17}{64}$.546875	$\frac{51}{64}$.796875
$\frac{4}{64}$.062500	$\frac{5}{32}$.312500	$\frac{25}{64}$.562500	$\frac{52}{64}$.812500
$\frac{5}{64}$.078125	$\frac{6}{32}$.328125	$\frac{33}{64}$.578125	$\frac{53}{64}$.828125
$\frac{6}{64}$.093750	$\frac{7}{32}$.343750	$\frac{41}{64}$.593750	$\frac{54}{64}$.843750
$\frac{7}{64}$.109375	$\frac{8}{32}$.359375	$\frac{49}{64}$.609375	$\frac{55}{64}$.859375
$\frac{8}{64}$.125000	$\frac{9}{32}$.375000	$\frac{57}{64}$.625000	$\frac{56}{64}$.875000
$\frac{9}{64}$.140625	$\frac{10}{32}$.390625	$\frac{65}{64}$.640625	$\frac{57}{64}$.890625
$\frac{10}{64}$.140625	$\frac{11}{32}$.406250	$\frac{73}{64}$.656250	$\frac{58}{64}$.906250
$\frac{11}{64}$.171875	$\frac{12}{32}$.421875	$\frac{81}{64}$.671875	$\frac{59}{64}$.921875
$\frac{12}{64}$.187500	$\frac{13}{32}$.437500	$\frac{89}{64}$.687500	$\frac{60}{64}$.937500
$\frac{13}{64}$.203125	$\frac{14}{32}$.453125	$\frac{97}{64}$.703125	$\frac{61}{64}$.953125
$\frac{14}{64}$.218750	$\frac{15}{32}$.468750	$\frac{105}{64}$.718750	$\frac{62}{64}$.968750
$\frac{15}{64}$.234375	$\frac{16}{32}$.484375	$\frac{113}{64}$.734375	$\frac{63}{64}$.984375
$\frac{16}{64}$.250000	$\frac{17}{32}$.500000	$\frac{121}{64}$.750000	$\frac{64}{64}$	1.000000

MISCELLANEOUS

- 1 cu. ft. of water weighs 62.36 lbs. at 62° F. at sea level.
- 1 cu. ft. of water equals 7.48 U. S. gals.
- 1 cu. ft. steam weighs .063 lbs. at 10 lb. per sq. in gauge pressure; .153 lbs. at 50 lb. pressure.
- .262 lbs. at 100 lb. pressure; .471 lbs. at 200 lb. pressure.
- 1 lb. of condensation equals the loss of 946 B. T. U. at 10 lb. gauge pressure.
- 1 lb. of condensation equals the loss of 855 B. T. U. at 150 lb. gauge pressure.

TABLE VIII
Areas of Circles

Dia.	Area	Dia.	Area	Dia.	Area	Dia.	Area	Dia.	Area
$\frac{1}{8}$	0.0123	$3\frac{1}{4}$	8.295	$12\frac{1}{2}$	122.71	$22\frac{1}{2}$	397.60	40	1256.6
$\frac{1}{4}$	0.0491	$3\frac{1}{2}$	9.621	13	132.73	23	415.47	41	1320.2
$\frac{3}{8}$	0.1104	$3\frac{3}{4}$	11.044	$13\frac{1}{2}$	143.13	$23\frac{1}{2}$	433.73	42	1385.4
$\frac{1}{2}$	0.1963	4	12.566	14	153.93	24	452.39	43	1452.2
$\frac{5}{8}$	0.3067	$4\frac{1}{2}$	15.904	$14\frac{1}{2}$	165.13	$24\frac{1}{2}$	471.43	44	1520.5
$\frac{3}{4}$	0.4417	5	19.635	15	176.71	25	490.87	45	1590.4
$\frac{7}{8}$	0.6013	$5\frac{1}{2}$	23.758	$15\frac{1}{2}$	188.69	26	530.93	46	1661.9
1	0.7854	6	28.274	16	201.06	27	572.55	47	1734.9
$1\frac{1}{8}$	0.9940	$6\frac{1}{2}$	33.183	$16\frac{1}{2}$	213.82	28	615.75	48	1809.5
$1\frac{1}{4}$	1.227	7	38.484	17	226.98	29	660.52	49	1885.7
$1\frac{3}{8}$	1.484	$7\frac{1}{2}$	44.178	$17\frac{1}{2}$	240.52	30	706.86	50	1963.5
$1\frac{1}{2}$	1.767	8	50.265	18	254.46	31	754.76	51	2042.8
$1\frac{5}{8}$	2.073	$8\frac{1}{2}$	56.745	$18\frac{1}{2}$	268.80	32	804.24	52	2123.7
$1\frac{3}{4}$	2.405	9	63.617	19	283.52	33	855.30	53	2206.1
$1\frac{7}{8}$	2.761	$9\frac{1}{2}$	70.882	$19\frac{1}{2}$	298.64	34	907.92	54	2290.2
2	3.141	10	78.540	20	314.16	35	962.11	55	2375.8
$2\frac{1}{4}$	3.976	$10\frac{1}{2}$	86.590	$20\frac{1}{2}$	330.06	36	1017.8	56	2463.0
$2\frac{1}{2}$	4.908	11	95.030	21	346.36	37	1075.2	57	2551.7
$2\frac{3}{4}$	5.939	$11\frac{1}{2}$	103.86	$21\frac{1}{2}$	363.05	38	1134.1	58	2642.0
3	7.068	12	113.09	22	380.13	39	1194.5	59	2733.9

To find the area of a circle when diameter is given, multiply the square of the diameter by .7854.

From Standard Authorities—Not Guaranteed

SECTION IV

Water Columns
Water Gauges and Try Cocks
Gauge Glass Protectors
Pump Governors
Feed Water Regulators

BULLETIN No. 503

PAGE NUMBERS, mentioned in the text of this catalog, apply to the Section or Bulletin in which the references occur.

Wright-Austin Safety Alarm Water Columns

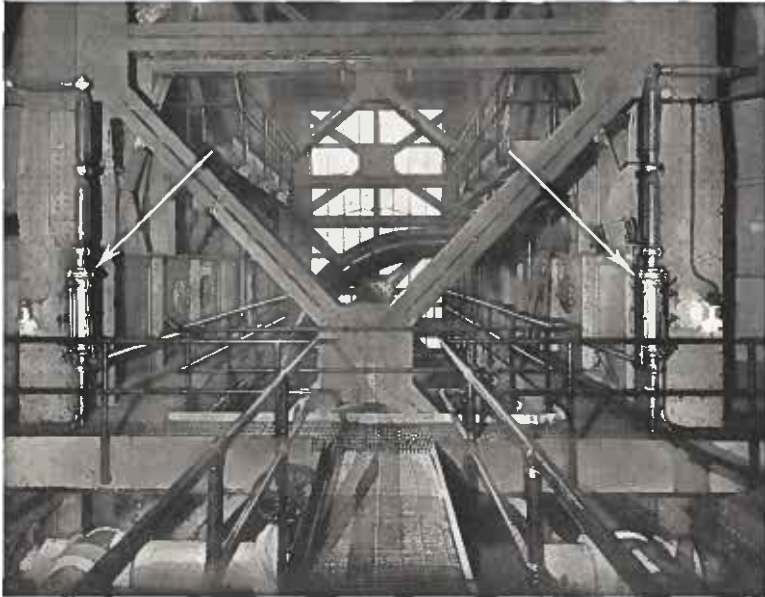

Two Columns Out of a Total of Sixteen Installed in a Modern Power Plant. 8-2640 H. P. Boilers, 250 Lbs. Pressure, 200°F Superheat

Dependability
Safety Long Life
Simplicity
Accessibility
Outside Type
Whistle Valve



Column Complete
with "Quick Change"
Water Gauge,
"Crescent"
Try Cocks, & "Kleervu"
Gauge Glass Protector

ALARM WATER COLUMNS FOR BOILERS

Among modern engineers the necessity of alarm water columns on boilers is no longer a question. Their economic and protective advantages are too well known.

However, all executives have not had opportunity to investigate the engineering features of alarm water columns, and we would like to point out that when the fluctuations of water level in any boiler are confined to a set minimum distance, many advantages naturally follow.

First: Wright-Austin Alarm Columns on boilers enable you to save money in the following seven ways:

1. Water level maintained within a safe fixed range.
2. Less water in the steam.
3. Smaller fuel consumption.
4. Less contraction and expansion.
5. Less repairs.
6. Longer boiler life.
7. Reduced wear and tear on feed pumps.

Second: The savings resulting from the proper water level go on year after year without cost.

Third: Disaster from too high or too low water level is prevented. When automatic feed water regulators are used, alarm columns are even more necessary as a check on the regulator and, should the regulator not function or water supply fail, the man in charge hears the alarm of the column whistle before the water reaches the danger mark.

Fourth: The operator will welcome the alarm as it gives concrete evidence of his care and attention.

Also, when boilers are operated all the way from 200% to 300% of normal rating, water is frequently forced over, on account of a sudden demand for steam; on account of priming; or merely because of carrying a high water level. As superheaters cannot evaporate even the smallest slug of water, the turbine or engine must suffer. Each one per cent of moisture in the steam will cause a drop of approximately 15 degrees in the superheat.

So important are these features that on modern, large, high pressure boilers it is not unusual to see two alarm columns used on each unit. In fact, alarm columns have come to be universally accepted as being almost as necessary as the safety valves on all sizes and types of pressure boilers. There is no more important device on any steam boiler than the water indicating mechanism.

The great disasters and loss of life caused by the explosion of boilers in the smaller plants are cruel reminders of the extreme and urgent need of every possible precaution.

As none are exempt, the added safety factor of an alarm column is indeed a protection. Prevention of one accident will more than save the cost of several hundred Wright-Austin Alarm Columns.

Some states compel the installation of alarm columns on all boilers operated over 10 or 15 pounds pressure. WRIGHT-AUSTIN ALARM COLUMNS MEET ALL BOILER CODES. All insurance companies approve them. Consulting and Plant Engineers almost invariably specify them. Their added cost to a boiler is negligible. They outlive the boiler.

GENERAL DESCRIPTION

Wright-Austin Columns are the perfected product of an experienced organization that has been manufacturing them since 1894.

They are of a round, symmetrical design, and add a finished appearance to any boiler. They are of extra heavy construction for modern high pressures, but designed to operate equally well under low pressure.

Two kinds are made. One gives the high water alarm and also the low water alarm—called the Combined High and Low Water Alarm Column.

The other gives the signal for low water only and is referred to as the Low Water Alarm Column.

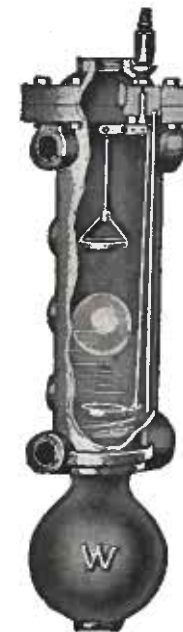

Combined High and Low Water Alarm Column



Low Water Alarm Column

Extremely Simple Internal Parts Are Features of W-A Columns. See Pages 22 and 23

OPERATION

Combined High and Low Water Alarm Column

One simple, inside operating unit sounds BOTH the high and low water alarms. It has but one vertical valve and one round float. The float is without any rods or connections and, as shown above, merely idles on the water between the high and low levels.

When the water in the boiler lowers sufficiently, the weight of the float on the bottom basket opens the whistle valve for the low water signal. Should the boiler become too full of water, the float is raised up against the top basket, its buoyancy operating the SAME whistle valve as for the high water alarm.

This simple, single unit construction has the advantage of moving all parts at every alarm—either high or low. Whenever it is desired to test either alarm, the operator merely blows down the Column—a unique Wright-Austin feature.

The common practice of blowing down all water columns each day automatically tests both alarms, by giving all parts a full movement. This daily exercise precludes the possibility of any part becoming corroded and sticking, even if water does not reach high or low levels in the boiler for months at a time. Therefore, it is never necessary to pump the boiler full of water to test the high alarm.

The low water alarm is sounded before the water passes out of sight at the bottom of the gauge glass, while the signal for high water will be given as the water nears the top of the glass, or approximately opposite the top and bottom try cocks on the standard sizes of columns.

Low Water Alarm Column

This type gives the alarm for low water only and its extreme simplicity is readily appreciated by every engineer.

The float is directly connected to the whistle valve, and holds it shut as long as the water remains high enough to support the float. But, as soon as the water falls below the low water alarm level, the float drops with it, instantly opening the valve of the alarm whistle.

The alarm will be sounded just before the water passes out of sight in the gauge glass on the Column. Also, every time the Column is blown down, the alarm will be sounded, which serves as a test.

ACCESSIBILITY

The inside parts are attached to cover only. They may be taken entirely out of the Column by simply lifting off the cover. Putting the cover back replaces the inside parts. When back steam connection is used, it is not necessary to break any pipe connection. If top steam connection is used, then it is only necessary to break union (or flange) joint in steam pipe to boiler.

MATERIALS

The body and cover are regularly made of semi-steel. They may also be furnished in genuine electric furnace cast steel, when desired, at special rates. All inside parts are of good high-grade brass, and float of double thickness laminated nickel. High pressure columns are also made of forged steel.

THE FLOAT

Only one float is used in Wright-Austin Columns. This is a high pressure, seamless, nickel float of double thickness, (except No. 0 Victor Junior which has a copper float). Being spherical in shape—perfectly round—the strains are equal in all directions, making the very strongest kind of float construction. The nickel float successfully stands hydrostatic tests of 1200 lbs. per sq. inch.

DEPENDABILITY

The dependability of the Wright-Austin Alarm Column is its strongest and most important feature. The Column is so constructed that every part is moved and exercised each time it is blown down for a water level test of the boiler. Naturally it is impossible for the inside parts to become corroded and stick, during the short interval of a few hours between the regular column blow-downs. It will thus be clear to everyone that it is the most dependable of all alarm columns.

These, and other points of superiority, make the Wright-Austin Columns widely specified by Consulting and Power Plant Engineers and extensively used in the most modern steam plants.

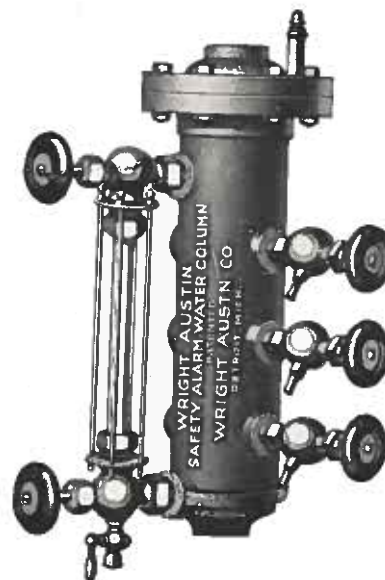

"Victor" Type Column Without Sediment Chamber

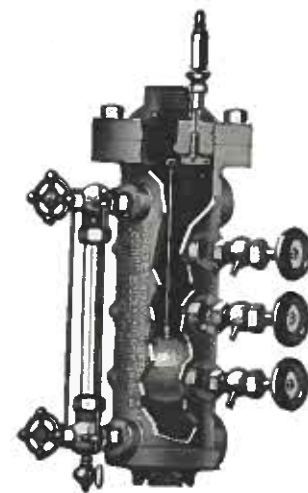

No. 0 "Victor, Jr." Low Water Alarm Column

"VICTOR" TYPE COLUMN

When it is desired to make the water connection in the bottom of the column, the sediment chamber is omitted. To designate this column it is called the "Victor" Type.

It is made in either Combined High and Low Water Alarm or Low Water Alarm only and is the same as the regular columns in all respects, except for the omission of the sediment chamber.

This arrangement does away with flanges and nipples between the column and the boiler, directly back of the column. Therefore, the space occupied by such connections is saved and the column can be brought close to the boiler itself.

No. 0 "VICTOR, JR.," COLUMN

This is a small column especially designed for small boilers. It is largely used in heating plants, bakeries, laundries, dry cleaning and pressing establishments, clothing shops, tire vulcanizing shops, etc.

It is made with Low Water Alarm only and gives the same loud signal as the larger columns. The inside alarm mechanism, also, is the same simple design as used in the larger Low Water Alarm Columns. It is suitable for all working pressures up to 200 pounds, but operates equally well under low pressure.

For convenience in installing, the choice of four connections may be used; a top or side steam connection, and a bottom or side water connection. These four connections are tapped for 1" pipe.

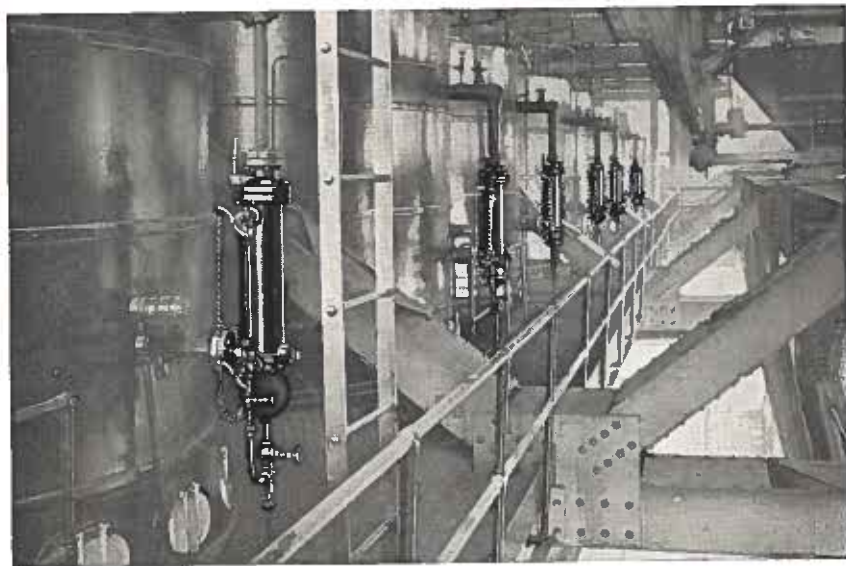

PRICES, WEIGHTS AND CONNECTION DIMENSIONS

HIGH AND LOW WATER ALARM

Dimensions in Inches

Size No. of Column	Kind and Size of Boiler	Steam and Water Connections Variation Between Alarms	Water Gauge Connections	Gauge Glass	Try-Cocks	Weight	Boxed for Export or Domestic Shipment	List Price Including Whistle, No Water Gauge or Try Cocks	Code Word
1	36" to 54"	1*	6	5/8x12	1/4	67	83	\$28.00	Water
3	36" to 54"	1 1/4	7	3/4x12	3/8	80	98	29.00	Windy
5	56" to 72"	1 1/4	8	3/4x16	3/4	88	107	30.00	Weave
7	Watertube	1 1/2	12	3/4x19	3/4	94	115	35.00	Weary
9	Watertube	1 1/2	18	3/4x22	3/4	114	138	40.00	Weald
11	Watertube	1 1/2	24	3/4x28	3/4	128	154	42.50	Waxen
15	Watertube	1 1/2	36	3/4x40	3/4	164	198	50.00	Welsh

LOW WATER ALARM ONLY

0	Small Types	1	..	3/8	5/8x 6 1/4	3/8	23	38	\$15.00	Watjr
2	36" to 54"	1	..	1/2	5/8x12	1/2	61	77	25.00	Whisk
6	56" to 72"	1 1/4	..	3/4	3/4x14	3/4	70	89	28.00	White
8	Watertube	1 1/2	..	3/4	3/4x19	3/4	75	96	35.00	Wager

Monel Metal Whistle Valve described on Page 13 can be furnished extra—List Price \$9.00

*No. 1 Column can be tapped for 1 1/4" steam and water connection, also for 3/4" water gauge and try-cock if specified.

†Two glasses joined at center with stuffing box. Four try-cocks.

All columns are tapped for try-cocks on both sides so they may be installed as either right hand or left hand columns.

DIMENSIONS OF WRIGHT-AUSTIN SAFETY ALARM WATER COLUMN

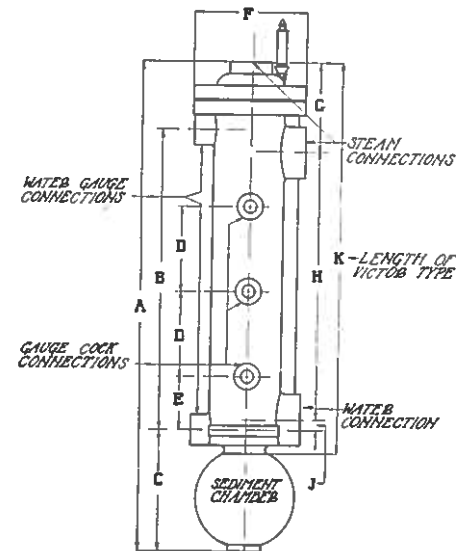

Our Engineering Service is Available at All Times

Order Water Gauges and Try-Cocks with Columns

*K-DON-OFF ALL COLUMNS EXCEPT NO. 0 VICTOR JR. 1"

HIGH AND LOW WATER ALARM

Dimensions in Inches

Size No. of Column	A Length Overall	B Water Gauge Centers	C Gauge Connection to Bottom of Column	D Try-Cock Centers	E Lowest Try-Cock to Gauge Connection	F Diameter of Flanges	G Steam Connection to Top of Column	H Center to Water to Steam Connections	J Center to Water to Gauge Connections	K Victor Column Length Overall
1	26 1/2	14	7 1/2	3	3	8	5	14	0	20 1/4
3	27 1/4	14	8	4	3	8	5	14	0	21
5	31 1/4	18	8 1/2	4	4	8	6	16	3/4	23 3/4
7	34 1/4	21	8 1/2	6	3 1/2	8	6 1/4	19	1/2	27 1/4
9	39	24	9	9	3	9	5 1/2	24 1/2	0	32 1/4
11	45	30	9	12	3	9	See Foot Note		0	38 1/4
15	57	42	12	12	3	9			1	50 1/4

LOW WATER ALARM ONLY

0	13 1/2	7 1/2	2	3	3/4	5	4	7 1/2	0	13 1/2
2	26 1/2	14	7 1/2	3	3	8	5	14	0	20 1/4
6	29	16	8 1/2	4	3 1/2	8	6	14	1/2	22
8	34 1/4	21	8 1/2	6	3 1/2	8	*	*	3/4	27 1/4

*Columns No. 7, No. 8 and larger are provided with a steam connection in center of cover at top or with a back steam connection when specified.

NOTE:—For the average boiler select a size of Wright-Austin Column, which has top and bottom water gauge connections spaced so that they will be approximately opposite the mean high and low water levels of the boiler, as allowed by the boiler manufacturer. In other words use the size of Wright-Austin Alarm Column, which has the same distance between the extreme water gauge connections that occurs on the plain column furnished with the boiler, or recommended by the boiler manufacturer.

**“STANDARD SPECIAL” COLUMNS
FOR LARGE BOILERS**

“Standard Special” Safety Alarm Water Columns are made to suit customers’ special conditions from standard design and standard patterns, which have been thoroughly tested. This insures an engineer receiving the benefit of the thirty-five years of Wright-Austin experience in Alarm Water Column manufacture, at the same time that he obtains a column to fit his particular boiler. This also reduces the cost of special columns considerably.

Columns can be furnished in cast semi-steel for pressures up to 250 lbs. per sq. in., in cast steel for pressures up to 350 lbs. per sq. in. or in forged steel up to 650 lbs. per sq. in. Floats are of nickel, tested to 1200 lbs. per sq. in. hydraulic pressure. The internal mechanism is simple and reliable. The more severe the service, the more valuable this sturdy simplicity becomes.

Columns can be furnished with flanged steam and water gauge connections, in any of the styles shown in illustrations on this page and the next, also with flanged water gauge connections. In many cases it is possible to vary the dimensions of the try-cocks, steam and water connections, etc., from the figures given in the table to suit particular conditions. However, the columns listed will be found suitable for a number of conditions and these can be furnished usually in about two weeks’ time. Consult the Wright-Austin Engineering Department when special conditions must be met.

Non-leaking Outside Monel Metal Whistle Valve can be supplied if desired. (See Page 13 for description).

“Crescent” Weighted Try-Cocks which are non-leaking for high pressures are also available. (See Pages 16 and 17).

Extra Heavy Water Gauges with glass replacing union have been made especially for this service. (See Page 15).

These three devices are recommended for use on all “Standard Special” Water Columns.

These columns are not made up from pipe and flanges, nor built up in any other manner; they are cast in one piece without any joint, except that between the body and the cover. It is not necessary to reach down inside the column to take it apart. All internal mechanism comes out with the cover and can be repaired or adjusted at a convenient workbench. The Outside Monel Metal Whistle Valves and “Crescent” Weighted Try-Cocks are built so that the valves can be reversed, or reground, from outside the column, without removing the connection to the column or column cover.



**Type No. 39
Alarm Water
Column**



**Type No. 42
Alarm Water
Column**

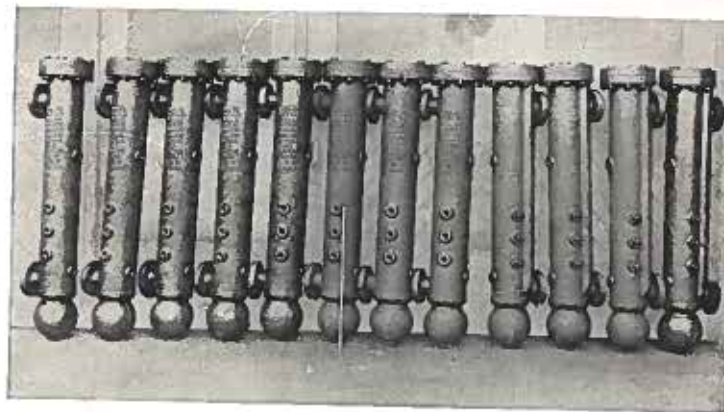

Type No. 29 Alarm Water Columns

**MEASUREMENTS OF “STANDARD SPECIAL” COLUMNS.
Dimensions in Inches**

Size Number of Columns	Length Overall	Distance Between Steam and Water Connections	Size of Steam and Water Connections	Water Gauge Centers	Size of Gauge Glass	Water Gauge Connection	Distance Between Try-Cocks	Size of Try-Cock Connection	Blow-off Size	Distance C/L Water Connection to Bottom of Column	Distance C/L Water Connection to C/L Lowest Try-Cock	Distance C/L Water Connection to Lowest Water Gauge Connection	Weight
27*	38 1/2	21	1 1/2	21	3/4 x 19	3/4	6	3/4	3/4	10	3 1/2	1	163
28*	43 5/8	26 5/8	1 1/2	16	3/4 x 14	3/4	4	1 1/2	3/4	10 1/4	3 3/4	1 1/4	200
29*	48 1/2	31 1/8	1 1/2	20	3/4 x 18	3/4	4	1 1/2	3/4	10 1/4	5	2	220
36**	39 7/8	26 3/8	1 1/2	16	3/4 x 14	3/4	4	1 1/2	3/4	10 1/4	3 3/4	1 1/4	172
42**	44 3/4	31 1/8	1 1/2	20	3/4 x 18	3/4	4	1 1/2	3/4	10 1/4	5	2	192
38†	42 1/8	26 5/8	1 1/2	16	3/4 x 14	3/4	4	1 1/2	3/4	10 1/4	3 3/4	1 1/4	170
39†	47	31 1/2	1 1/2	20	3/4 x 18	3/4	4	1 1/2	3/4	10 1/4	5	2	190

Prices on application.

NOTES:

These columns can be furnished with flanged water gauge connections instead of screwed connections if desired.

Within limits dimensions of these columns can be modified to suit special conditions.

Try cock connections can be made 3/4" when specified.

*Items marked with an asterisk have flanged steam and water connections on back of column and screwed water gauge connections. (See illustration of No. 29 Column).

**Items marked with a double asterisk have flanged steam and water connections and screwed water gauge connections, but the steam connection is through an ell fitting leading into top of column. (See illustration of No. 42 Column).

†Items marked with a dagger have flanged steam and water connections and screwed water gauge connections, but the steam connection is made through the cover of the column. (See illustration of No. 39 Column which also shows the flanged type of water gauge connection).

Former No. FF Column becomes No. 42. Former No. 42A becomes No. 29.



Fifty Standard No. 5 Columns on One Order Awaiting Shipment

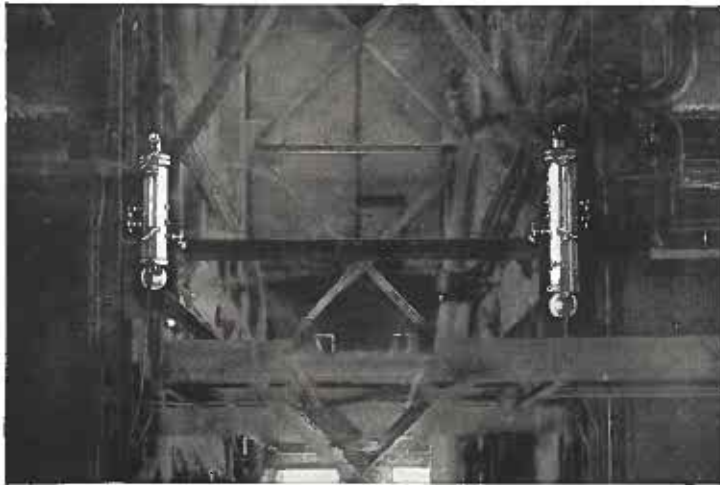

Two of the Six Flanged Wright-Austin Columns in the Municipal Power Plant, City of Lansing

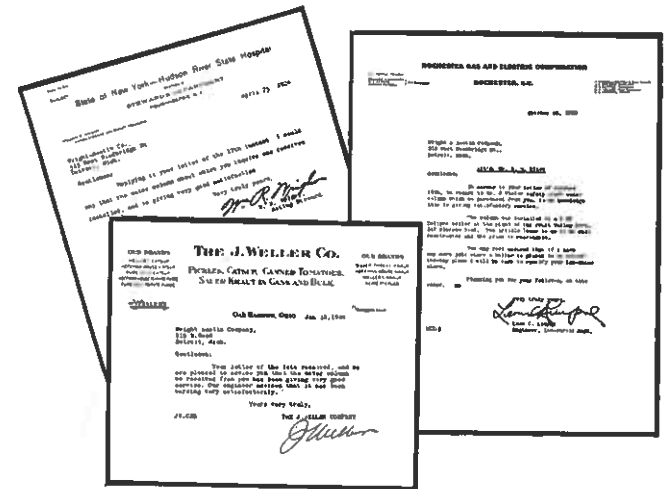

Some Replies to Our Service Letters

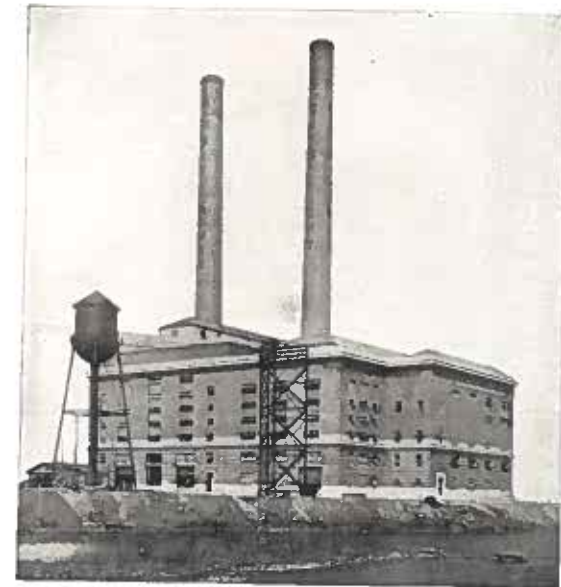

Municipal Power Plant, City of Lansing, Mich.
Six Flanged Columns on Type V Heine Boilers

WRIGHT-AUSTIN "BROWNIE" BOILER WATER SIGNAL

A Low Water Alarm for Small Boilers

For Pressures from 3 to 150 Lbs.

This Signal sounds a shrill whistle alarm when water is low in the boiler and is particularly adapted for small boilers. Its price is very reasonable and it can be connected with tees to the water gauge, without tapping extra holes in the boiler.

It is ruggedly built, simple and reliable, having only three moving parts. All internal parts are attached to, and removable with the cover.

These features make it possible for the owner of a small boiler to have the same effective protection against low

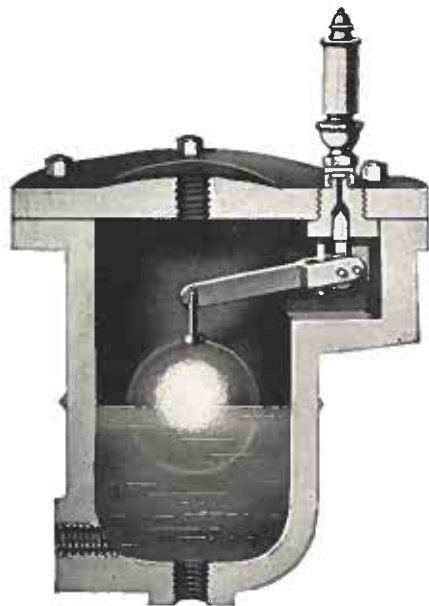

water as the large plant, at a minimum price.

The Signal is easily installed, as shown in the illustration at the left. The low water level line should be set at the lowest water level desired, at which the whistle will blow.

PRICE AND DIMENSIONS

Size of Connections and Drain.....	1/2"
Base to Top of Whistle.....	13"
Base to Top of Cover.....	7 3/4"
Base to Center Line of Side Connection.....	1 1/4"
Diameter of Cover.....	6"
Distance Center Line of Signal to Face of Boss on Side Connection.....	2 3/8"
Weight.....	15 lbs.
List Price with Whistle (No Fittings)....	\$12.00
Code Word.....	Woods

Can also be furnished with 3/4" connections if ordered.

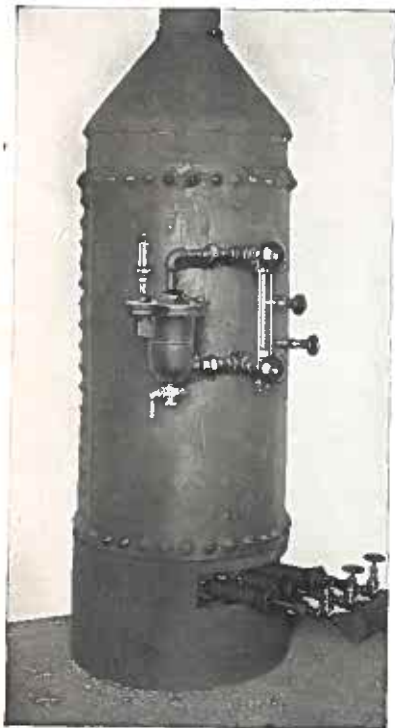

"Brownie" Boiler Signal in Position on Small Boiler

WRIGHT-AUSTIN MONEL METAL WHISTLE VALVE

Three Distinct and Exclusive Features Combined in One Simple Compact Valve

1. Entire valve outside of Water Column. Seat and valve are reversible or renewable, without detaching column cover or any column connections.

2. Easy access to valve and seat. Only necessary to unscrew two small parts—the valve hood and valve casing.

3. Double life, because of reversible, double end valve and seat.

The complete valve is built for hard service with monel metal cone valve and disc seat. Other parts are first quality brass.

This valve can be substituted for the regular column whistle valve, on all sizes of Wright-Austin Water Columns except the No. 0 Victor Jr. Column, at slight additional cost. It can be furnished with new columns, when these are purchased, or can be added to columns already in use.

On columns now in use the monel metal valve replaces parts J and K of the old attachment (Parts A and B on columns having low water alarm only). See Pages 22 and 23. It is recommended, although not obligatory, that a complete new attachment be purchased when replacing an old type whistle valve with a monel metal whistle valve. The advantage of factory assembly is thus obtained and extra parts removed from the column can be used as future spares.

Try this valve on your old column, or order it with your new column.

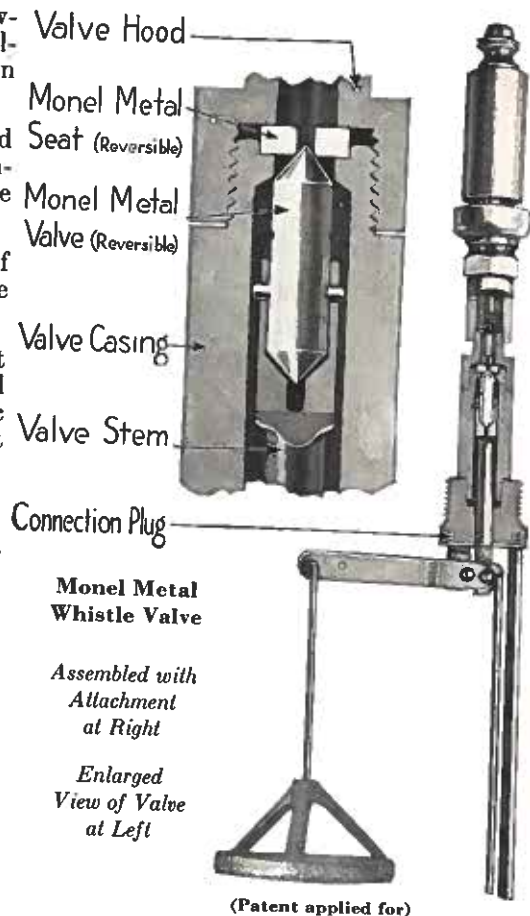

Water Gauges and Try-cocks

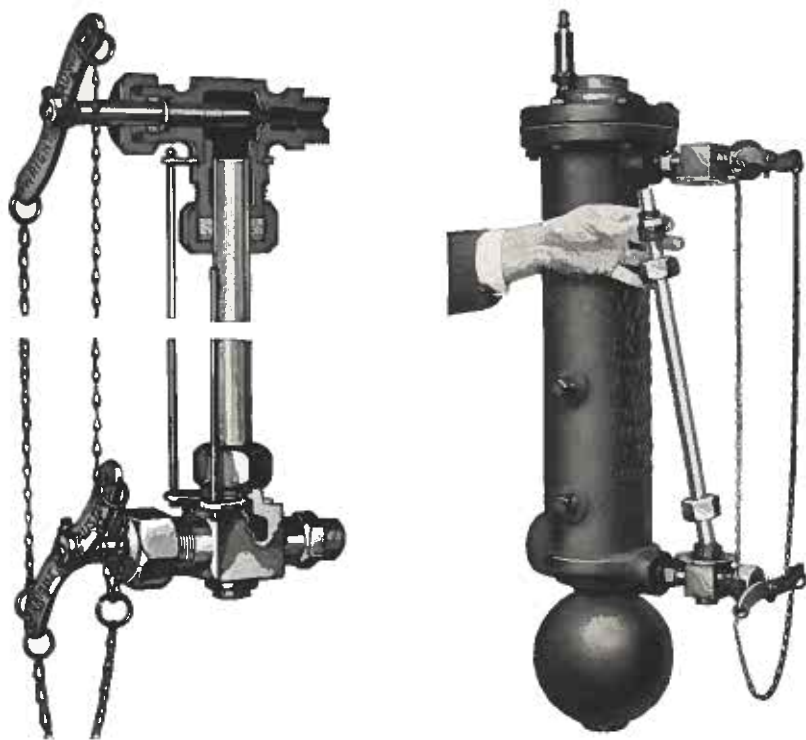

SAFETY CHAIN PULL WATER-GAUGE

For Pressures up to 250 Lbs. per Sq. In.

When the glass breaks, one pull of the chain from the floor shuts off instantly both the steam and water, without risk of the operator being scalded. Only a quarter turn closes or opens both top and bottom water-gauge valves together.

The valve bodies are square pattern, polished brass, of sturdy, substantial construction. The upper water-gauge fitting is made with a separate, removable, glass replacing union which permits renewal of a STANDARD LENGTH gauge glass, WITH THE WATER GAUGE VALVES SHUT AND BOILER PRESSURE ON THE WATER COLUMN.

The illustration above shows the method of inserting the standard length gauge glass, with the water-gauge valves closed.

The glass replacing union is shown in the hand at the top of the gauge glass. After the glass is in place, the union is screwed upward into position and then the packing nuts tightened, at the top and bottom of the gauge glass, in the usual manner.

If the gauge glass should accidentally be oversize in diameter, it can be inserted, without opening the water-gauge valves, by putting the top end in first.

Moistening of the glass will permit tight packing washers to slip on easily. Combined with the Wright-Austin Safety Chain Pull Try-Cock or "Crescent" Weighted Try-Cock, this Water-Gauge makes up a set of column trimmings which gives unequalled service for pressures up to 250 pounds.

In ordering Water-Gauges, it is advisable to give the CATALOG NUMBER, the SIZE, and the DISTANCE BETWEEN CENTERS of water-gauge valve connections

	List	Code
No. 110— $\frac{1}{2}$ " (Without Chain).....	\$10.00	Jetsa
No. 111— $\frac{3}{4}$ " (Without Chain).....	10.50	Jejun
Brass Chain per foot.....	.06	Jerlo

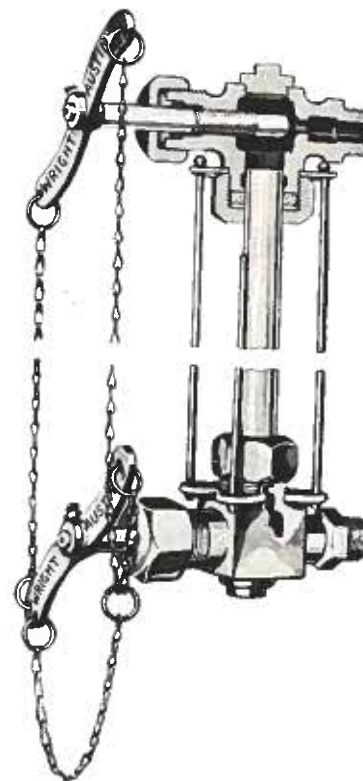

EXTRA HEAVY SAFETY CHAIN PULL WATER-GAUGE

For Pressures from 150 Lbs. to 400 Lbs. per Sq. In.

The cross sectional illustration above shows the extra size of all the parts of this water-gauge, as well as the details of the glass replacing union. The packing nuts on the gauge glass are large and deep, with ample room for packing, thus preventing breakage of the gauge glass and rendering the packing steam tight, up to working pressures of 400 lbs. per sq. in. The stuffing boxes on the valve stems are also large and provided with packing glands, so that they can be repacked without removing the lever.

When the glass breaks, one pull of the chain from the floor shuts off instantly both the steam and the water, without risk of the operator being scalded. Only a quarter turn closes or opens both top and bottom water-gauge valves, together.

The material used is the best grade of steam brass. The valve bodies are polished brass, square pattern, with four guard rods. We recommend this water-gauge for use wherever water-gauges have been giving trouble due to light construction, leaky packing, or broken glasses. It will successfully overcome these difficulties under pressure up to 400 pounds per square inch.

	List	Code
No. 121— $\frac{3}{4}$ " Extra Heavy Pattern (Without Chain).....	\$22.00	Jigic
No. 201— $\frac{3}{4}$ " Extra Heavy Flanged Pattern (Without Chain).....	*	Jiuji
Brass Chain per foot.....	.06	Jerlo

*Price on application.

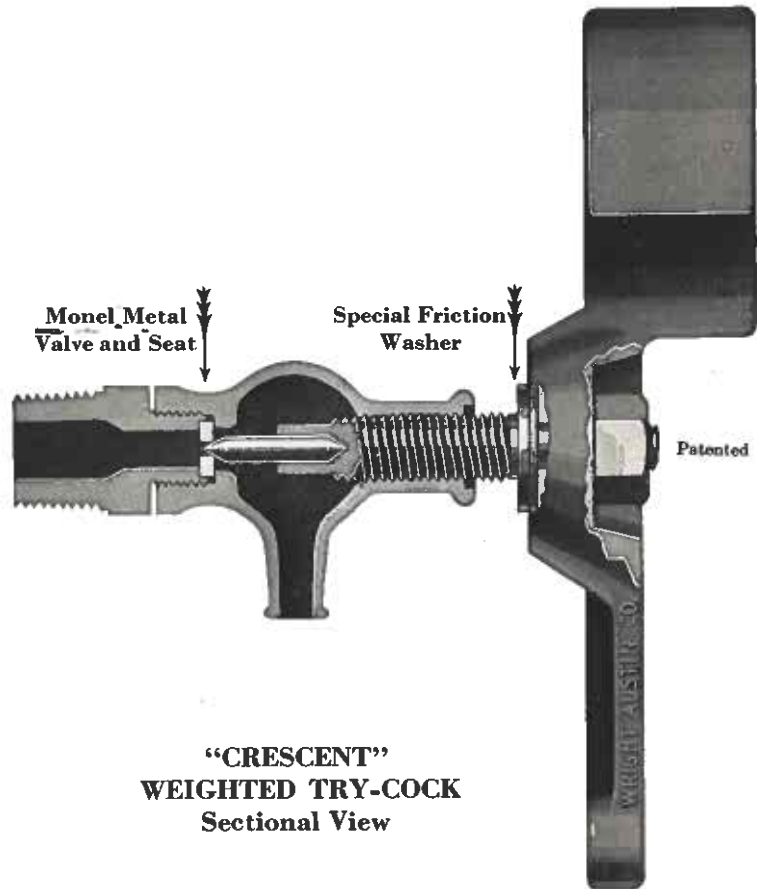

**“CRESCENT”
WEIGHTED TRY-COCK**
Sectional View

This Try-Cock is of extra heavy construction throughout, and is intended for both high and low pressure service. The valve and seat are monel metal. Both parts are reversible, giving double life, and both parts may be renewed by unscrewing the valve stem and body of the Try-Cock, without removing the shank from the water column or boiler.

The use of monel metal prevents all leakage even under high pressure. These Try-Cocks have been in actual use for a long time in some of the largest steam power stations in the United States, with absolutely satisfactory results, where many others failed.

A friction washer, eliminating cogs, permits very flexible adjustment of the weight on the valve stem, which is of great advantage in obtaining wide opening where Try-Cocks are closely centered (See Page 17.)

The body of the Try-Cock is made of brass semi-finished. The shank which screws into the Column is made of brass for pressures up to 300 lbs. per sq. in., and of steel for higher pressures.

	List	Code
No. 140— $\frac{1}{2}$ " Size (Without Chain) Brass Shank	\$4.50	Jacin
No. 141— $\frac{3}{4}$ " Size (Without Chain) Brass Shank	4.50	Jilts
No. 142—1" Size (Without Chain) Steel Shank	6.00	Jador
Brass Chain per foot	.06	Jerlo
Wire Handles, each	.10	Jocos

The $\frac{3}{4}$ " size can be furnished with a steel shank for high pressures—List \$5.50.

All sizes can be supplied with a lever instead of a weight, to use double chain, at the same price as the weighted type, if specially ordered. (See Detail "A," Page 17.)

Left hand Try-Cocks can be supplied at the same prices if specified.

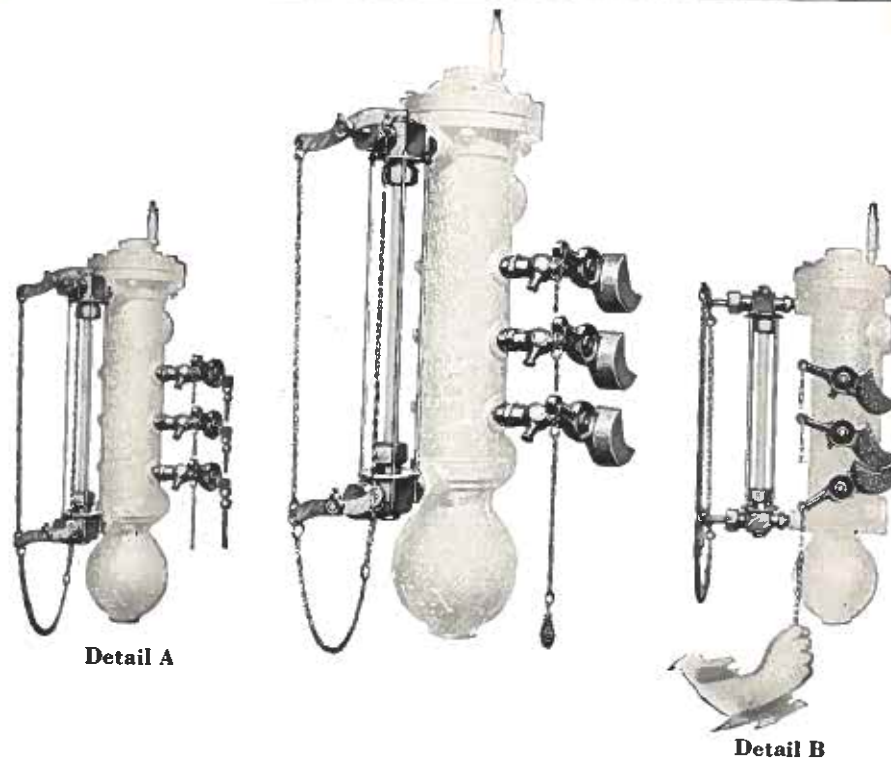

**SAFETY CHAIN PULL QUICK-CLOSING WATER-GAUGE AND
“CRESCENT” WEIGHTED TRY-COCKS**

The application of the “Crescent” Weighted Try-Cock to a Water Column is shown above. The central illustration shows the normal position of the Try-Cocks.

Detail “A” shows how the “Crescent” Try-Cock may be used with a lever and double pull chain instead of a weight. Detail “B” shows how the crescent shape of the weights permits wide opening of the Try-Cocks on close centers. This feature is unique with the “Crescent” Try-Cock and insures unusually wide opening.

The advantage of wide opening is that a true indication of water will be secured. With a small opening water may flash into steam, especially at high pressures, and give an erroneous indication. The “Crescent” Try-Cock prevents this and, even at very high pressures, the wide opening will cause water to show as it is.

The weight of the Try-Cocks is such that it can be used on the right or left hand side of the Water-Column as desired, with or without drip funnel.

The Try-Cock has been tested up to 2000 lbs. per square inch hydrostatic pressure without leakage.

Combination of 1—Chain Pull Water-Gauge including 4 feet of Drop Chain and 3—“Crescent” Weighted Try-Cocks, including 4 feet of Drop Chain with wire handles on each, complete for one Column.

	List	Code
$\frac{1}{2}$ " With No. 110 Water-Gauge	\$24.50	Joslu
$\frac{3}{4}$ " With No. 111 Water-Gauge	25.00	Jibet
$\frac{3}{4}$ " With No. 121 Extra Heavy Water-Gauge	36.50	Jitne

Prices and dimensions of Columns are given on Pages 6 and 7.



CHAIN PULL TRY-COCK
Sectional View

The valve in this Try-Cock closes tight with the pressure, and is not held shut by spring tension, as in other Try-Cocks.

The only function of the small spring is to raise the lever and return the disc to the seat, after the Try-Cock has been blown. The pressure holds it tight shut. The spring, which is made of a special non-corrosive metal, never comes in contact with the discharging steam or water and, not being affected by the heat, will give many years of service.

This Try-Cock is extremely simple and durable in construction. It is made with round body, of semi-finished brass.

	List	Code
No. 132— $\frac{1}{2}$ " size (Without Chain).....	\$4.50	Jakom
No. 133— $\frac{3}{4}$ " size (Without Chain).....	4.50	Juror
Brass Chain per foot.....	.06	Jerlo
Wire Handles each.....	.10	Jocos

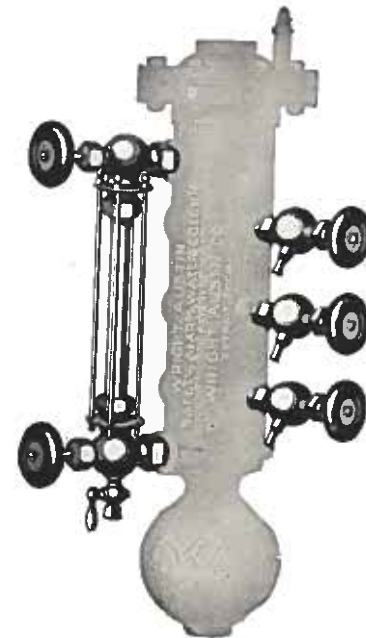

COMPRESSION TYPE WATER-GAUGE AND TRY-COCKS

For Pressures up to 200 Lbs. per Sq. In.

These are of good sturdy construction, having round body of polished brass. The Water-Gauge is made with four guard rods.

COMPRESSION WATER-GAUGE

No.	Size	List	Code
No. 101	$\frac{1}{4}$ "	\$3.20	Jalap
No. 105	$\frac{1}{2}$ "	3.50	Jaunt
No. 106	$\frac{3}{4}$ "	3.80	Jelly

COMPRESSION TRY-COCK

No. 131	$\frac{3}{8}$ "	\$.80	Jonah
No. 136	$\frac{1}{2}$ "	.85	Jorum
No. 137	$\frac{3}{4}$ "	.95	Joust

Combination of 1—Compression Water-Gauge and 3—Compression Try-Cocks complete for one Column.

$\frac{3}{8}$ " With No. 101 Water-Gauge.....	\$5.60	Jumbo
$\frac{1}{2}$ " With No. 105 Water-Gauge.....	6.00	Jingo
$\frac{3}{4}$ " With No. 106 Water-Gauge.....	6.60	Junny

Prices and dimensions of Columns are given on Pages 6 and 7.

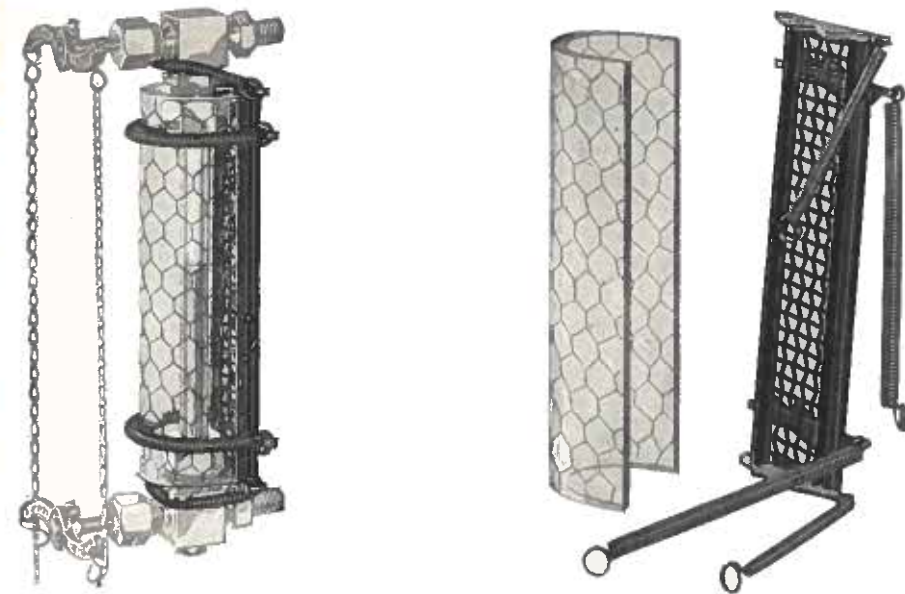

“KLEERVU” GAUGE GLASS PROTECTOR

The “Kleervu” Gauge Glass Protector prevents injury from exploding gauge glasses. It confines within the Protector the dangerously sharp, flying pieces of shattered gauge glass.

The “Kleervu” not only provides protection for gauge glasses on steam boilers, but for practically all kinds of liquid level gauges, such as those on stills, chemical containers, steam separators, air receivers, oil tanks, and other industrial process apparatus.

Considerable saving in breakage of gauge glasses is effected by the Protector shielding the gauge glass from cold drafts, which cause sudden changes of temperature with resultant breakage.

The advantages of the “Kleervu” Protector are, first—the clear view of the gauge glass from three sides which it affords, there being no bars or frames to obstruct the view; second—its exceptional strength due to the thickness of the protector glass and the wire in it, also to the exceptionally heavy screen; third—the ease with which the whole Protector can be snapped into position or taken off. The glass can be readily removed for cleaning, or replacing the gauge glass, without removing the screen. It takes only about thirty seconds to install or remove the Protector—and the springs hold it tightly in place.

The “Kleervu” Protector consists of a “U” shaped section of wire glass $\frac{3}{8}$ ” thick held by springs to a heavy wire screen forming the back. This in turn is attached by springs to the packing nut of the water gauge. The springs snap into position without bolts or other special fastening. The open area of the wire screen at the back is ample to permit escape of the steam. The Protector will fit practically any make of water gauge.

The illustrations show perhaps more clearly than any description just how the Protector is made. The Protector is made in two sizes. See next page for dimensions.

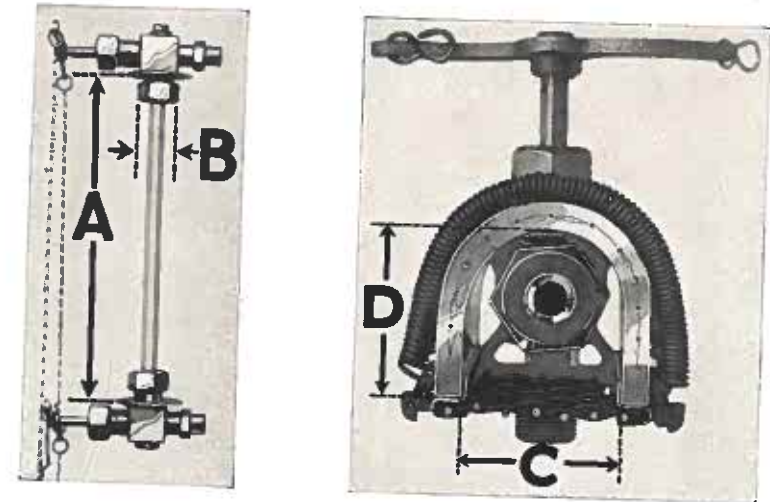

DIRECTIONS FOR ORDERING THE “KLEERVU” GAUGE GLASS PROTECTOR

In ordering give exact distance “A” (as shown in cut above), distance between guard rod holders on the upper and lower water gauge valves, also exact diameter “B” of packing nut as measured from corner to corner of nut.

Wherever possible make of Water Gauge should also be given, stating whether it has screwed or flanged connections to the Water Column. Length of Protector is governed by distance “A” between guard rod holders, and size of Protector Glass is governed by diameter “B” which is the extreme diameter of the packing nut.

Dimensions

Type No.	C	D	Code Word
11	As per cut above	As per cut above	Kedge Khaki
21	$2\frac{1}{8}$ ” $3\frac{3}{8}$ ”	$2\frac{3}{16}$ ” $2\frac{9}{16}$ ”	

Prices

Type No.	Distance Between Guard Rod Holders A	List Price
11	4” to 9” incl.	\$12.00 13.00 14.00 15.00 1.00 per inch
11	10” — 11” incl.	
11	12” — 13” incl.	
11	14” — 15” incl.	
11	All over 15”	
21	4” to 7” incl.	17.00 18.00 19.00 20.00 21.00 1.40 per inch
21	8” — 9” incl.	
21	10” — 11” incl.	
21	12” — 13” incl.	
21	14” — 15” incl.	
21	All over 15”	

PARTS FOR COMBINED HIGH AND LOW WATER
ALARM COLUMN

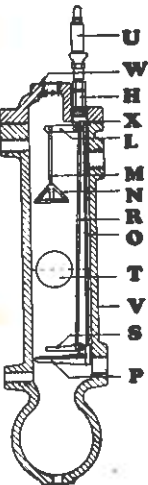

- H—Outside Monel Metal Whistle Valve
 - L—Lever
 - M—Top Basket Rod
 - N—Top Basket
 - O—Support Rod
 - R—Lower Basket Rod
 - P—Bottom Shoe
 - S—Bottom Basket
-
- T—Float
 - U—Whistle
 - V—Body
 - W—Cover
 - X—Gasket

{ Attachment Complete }



Outside Type Monel Metal Whistle Valve

When more than one or two parts are required we urge that the complete attachment be obtained. This reduces the time for making the replacement to a matter of a few minutes, and renews all wearable parts, so the Column is then practically as good as new. Whatever may be usable of the parts removed may be laid away for future spares.

When ordering be sure to give

1. LETTER and NAME OF PART,
2. SIZE NUMBER of Column cast on body.

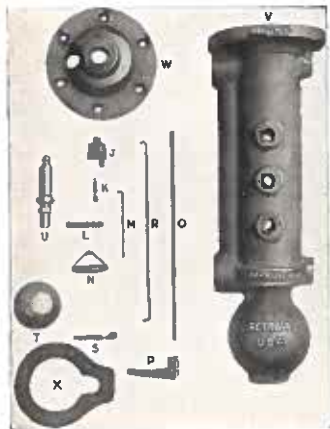

PARTS FOR LOW WATER ALARM COLUMN

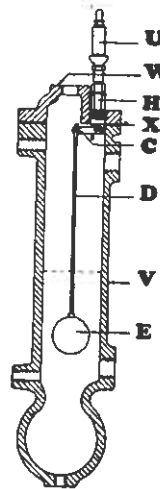

- H—Outside Monel Metal Whistle Valve
 - C—Lever
 - D—Float Rod
-
- E—Float
 - U—Whistle
 - V—Body
 - W—Cover
 - X—Gasket

{ Attachment Complete }



Outside Type Monel Metal Whistle Valve

Attachment Complete, as illustrated above, comprises all internal parts together with Outside Monel Metal Whistle Valve, but does not include the float or whistle. (For complete description of the Outside Monel Metal Whistle Valve see Page 13.) Attachment Complete consists of Parts H, C, D. If desired, Parts A and B (brass whistle valve and seat), shown in the view of separate parts at bottom of this page, can be substituted for Part H (Outside Monel Metal Whistle Valve). Parts A and B constitute the old style whistle valve. Attachment Complete is furnished in one unit, factory assembled and adjusted (whether Part H or Parts A and B are chosen) ready for service by simply screwing into the cover, the plug to which all parts are connected.

When more than one or two parts are required we urge that the complete attachment be obtained. This reduces the time for making the replacement to a matter of a few minutes, and renews all wearable parts, so the Column is then practically as good as new. Whatever may be usable of the parts removed may be laid away for future spares.

When ordering be sure to give

1. LETTER and NAME OF PART,
2. SIZE NUMBER of Column cast on body.

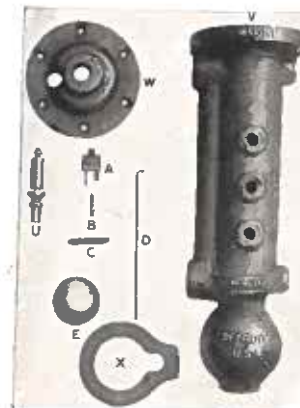

IMPORTANCE OF PROPER INSTALLATION OF THE WRIGHT-AUSTIN SAFETY ALARM WATER COLUMN

Statistics prove that every fourth or fifth boiler explosion is the result of defective installation of boiler fittings, hence, the importance of the correct installation of a dependable Alarm Water Column.

Connection to and from the Column should be as short and great in area as possible, and by means of plugged crosses rather than tees or elbows. This plan facilitates easy and frequent cleaning of pipes.

Fig. 1 illustrates an excellent installation. The top connection includes a gate-valve that can be opened and locked open. The drain pipe is nearly full size down to the sewer. When blowing into the sewer the lower drain valve should be opened and the upper gate valve connection closed, thus causing the water to flow out of the boiler, flushing out the pipes and Column and carrying with it any possible sediment or accumulation.

Some engineers prefer installations without valves in the piping between the boiler and the Column, as shown in Fig. 2.

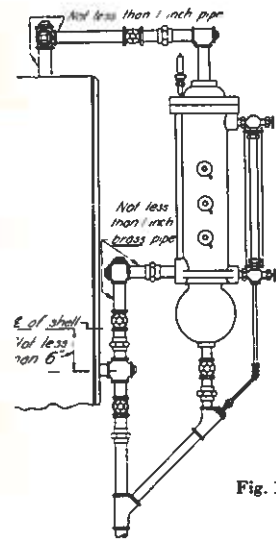

Fig. 1

Omitting valves from both the steam and water connections eliminates the possibility of a false water level showing in the gauge glass of the Column. This is sometimes caused, when valves are used, by leaving either the steam or water valve, or both, closed.

In cases where valves are used they should be either sealed or locked open. Although the valves for blowing out the sediment chamber and water gauge are shown close to the Column they, of course, can be installed so as to be accessible from the boiler room floor.

Provisions of A. S. M. E. Boiler Code With Respect to Water Columns

(Numbers refer to paragraphs in the latest 1927 edition of the "Code").

291. The lowest visible part of the water gauge glass must be at least 2" above the lowest permissible water level. The water gauge glass shall be equipped with a valved drain.

293. Shut-offs or valves in the connections to a water column must be either outside screw and yoke type gate valves, or stop cocks with permanently fastened handles and such valves or cocks shall be locked or sealed OPEN.

295. No outlet connections shall be placed on piping between water columns and boilers except those for damper regulators, feed water regulators, drains, steam gauges, or other apparatus which does not drain steam.

320. The minimum size of pipes connecting a water column to a boiler shall be 1".

321. Water connections shall be of brass provided with a cross to facilitate cleaning. Each column shall be fitted with drain cock or valve and a blow-off line 3/4" or over. Pockets shall be drained.

322. On horizontal return tubular boilers, the steam connection shall be taken out at or near the top of the shell; water connection shall be taken out 6" or more below center line of shell.

The construction of Wright-Austin Safety Alarm Water Columns conforms to the A. S. M. E. Code throughout.

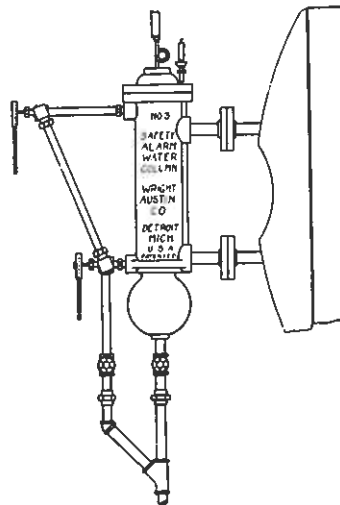

Fig. 2

Wright-Austin Automatic Pump Governor

With Weight Arm

DETAILS OF AUTOMATIC PUMP GOVERNOR

The Wright-Austin Pump Governor will never fail to maintain uniform pressure when using an Automatic Feed Water Regulator. It is equally serviceable when hand regulation of feed water is used.

The Governor is simplicity itself. There is nothing about it to get out of order and it can be used on water works, air, fire, boiler feed or elevator pumps.

The Governor is placed in the steam supply pipe to the pump and connected by 3/4" pipe to the discharge pipe of the pump, thereby regulating the exact amount of steam required for the pump to maintain a uniform pressure in the water discharge line.

Adjustment is made by moving the ball on the lever. Any pressure may be maintained in the discharge line.

For proper operation the pressure in the feed water line should be approximately 10 pounds in excess of the boiler steam pressure at all times.



Furnished in Globe Type Valve Bodies in Flanged and Screwed Patterns (See Page 31).

Application of Wright-Austin Pump Governor

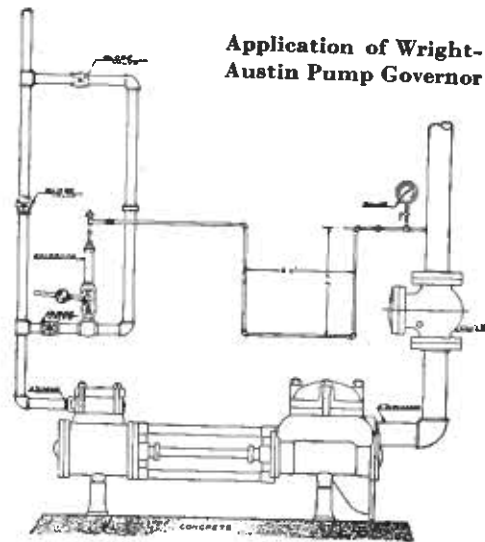

PRICE LIST

Size Inches	List Price Screwed Ends	Code Word
3/4	\$45.00	Yater
1	50.00	Yevta
1 1/4	55.00	Yuzer
1 1/2	70.00	Yimup
2	80.00	Yutac
2 1/2	85.00	Yiyki
3	95.00	Yoker

Prices with flanged ends on application

In Ordering Specify TYPE and SIZE of Valve Body

Wright-Austin Automatic Boiler Feed Water Regulator

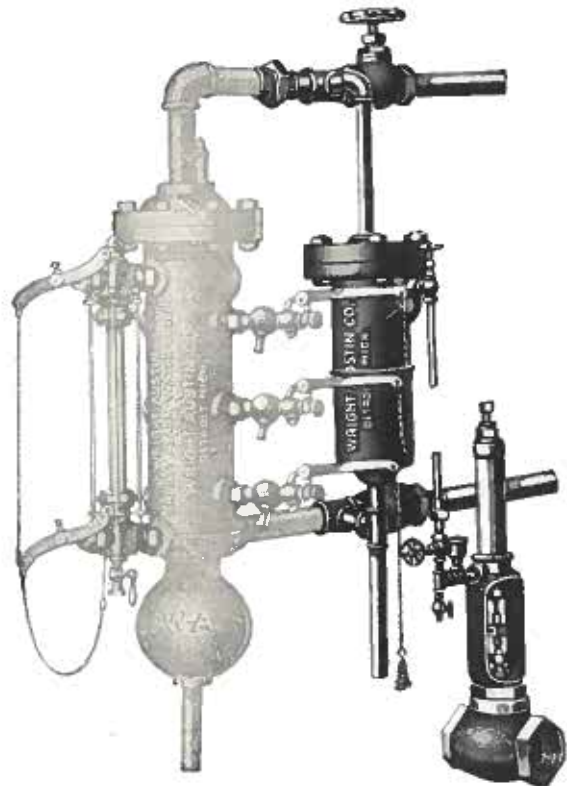

Exterior View showing also Wright-Austin Safety Alarm Water Column

Reliable Positive Unaffected by Temperature Changes

PRICE LIST

Size of Feed Water Line Inches	Screwed Valve Solid Seat List Price	Flanged Valve Solid Seat List Price	Renewable Monel Metal Seats Extra List Price	By-Pass Extra List Price	Shipping Weight Screwed Valve	Shipping Weight Flanged Valve	Code Word Size Only
1/2	\$83.00	45 lbs.	Unite
3/4	84.00	50 lbs.	Umbr
1	85.00	55 lbs.	Urban
1 1/4	94.00	\$28.00	\$15.00	60 lbs.	Usury
1 1/2	95.00	\$130.00	28.00	15.00	62 lbs.	65 lbs.	Ulys
2	100.00	135.00	31.00	15.00	65 lbs.	70 lbs.	Uhaen
2 1/2	105.00	140.00	39.00	15.00	67 lbs.	75 lbs.	Upsar
3	110.00	145.00	54.00	15.00	70 lbs.	100 lbs.	Uassa

Size of Regulator determined by size of individual feed water line to each boiler. Price includes Regulator Column.

Add list price for Monel Metal Seats, also By-Pass, or both if wanted, to list for either screwed or flanged patterns.

When ordering Specify TYPE of CONTROL VALVE BODY (See Page 31) also HORSEPOWER AND TYPE OF BOILER. This last is essential.

Sectional View Wright-Austin Automatic Boiler Feed Water Regulator

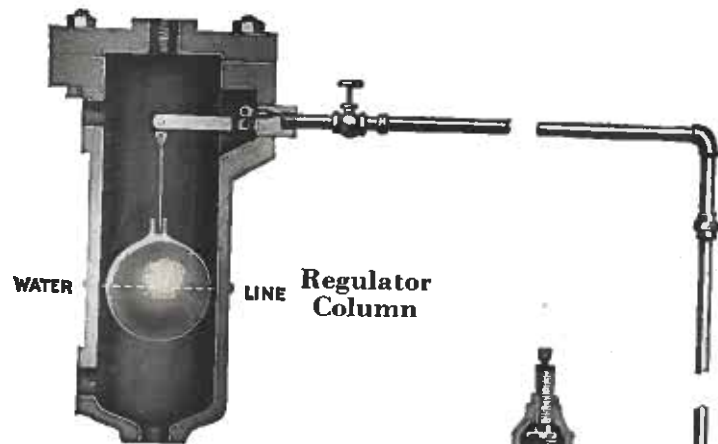

INSTALLATION

1. The Regulator Control Valve should be connected in the boiler feed water line as close to the boiler as possible.
2. The Regulator Column should be set so that the cast iron ring around its middle is at the desired water level of the boiler.
3. The Regulator Column should be connected to the steam and water space of the boiler with the shortest possible piping, and provided with a drain pipe and valve connecting the bottom of the Column to the sewer.
4. The Regulator Column should be connected to the Regulator Control Valve with 1/4" pipe, (or larger if the distance is considerable) supplied by the purchaser.

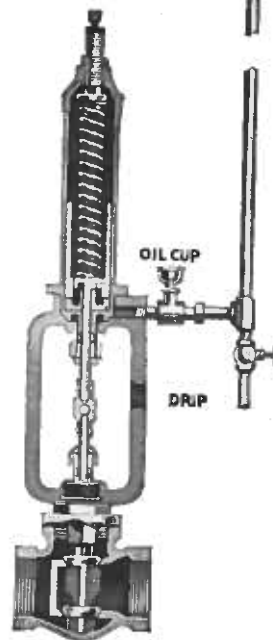

Regulator Control Valve

**APPLICATION AND VALUE OF WRIGHT-AUSTIN
AUTOMATIC BOILER FEED WATER REGULATOR**

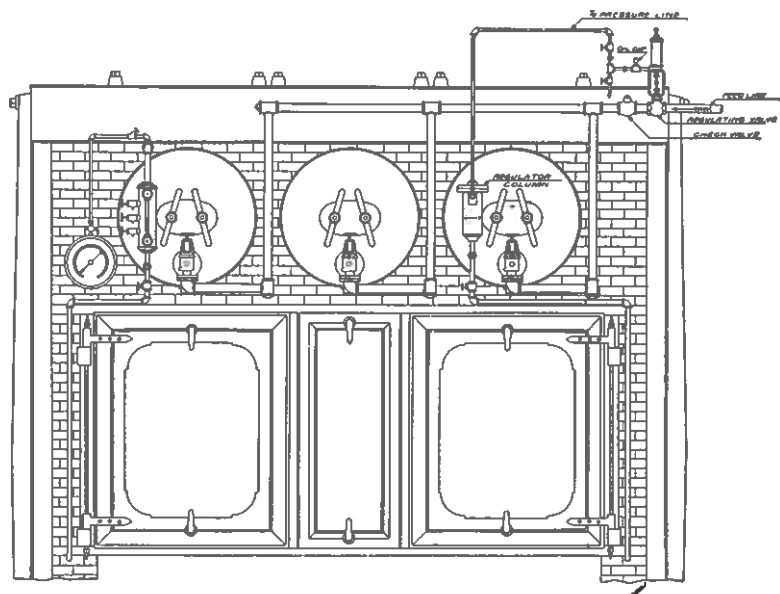

Wright-Austin Automatic Boiler Feed Water Regulator applied to a Horizontal Drum Type of Water Tube Boiler

THE WRIGHT-AUSTIN AUTOMATIC BOILER FEED WATER REGULATOR

Automatic regulation of boiler feed with a Wright-Austin Regulator shows a saving in fuel alone of from 5% to 15%, the percentage depending on general local conditions. The fact that Wright-Austin Regulators save this fuel is proof of a high uniform temperature of water in the boiler, as compared with the irregularity of temperature due to hand firing.

Also, from the standpoint of "safety," the Wright-Austin Regulator is an excellent investment. With it constantly on guard, high or low water in a boiler can only be due to unusual conditions.

High water level nearly always means wet steam, with its accompanying risk of damage to turbine blades, or engine cylinders. For well known reasons, a low water level is even worse.

The Wright-Austin Regulator feeds just enough water to keep the level uniform, feeding freely when the boiler is being "crowded"; slowly when it is running light. There is no waste of fuel on the boilers with a Wright-Austin Regulator in control of the feed water.

In designing the Wright-Austin Regulator, the modern idea was followed that water should be fed while the boiler is under load, in such a manner that, when peaks and overloads occur, the water level would be automatically lowered, at least temporarily, so as to quickly increase the steaming capacity of the boiler, and thus meet the new conditions. During normal and no load conditions, the water level would be raised, so as to store up heat energy, which would otherwise be wasted through the pop valve or up the stack.

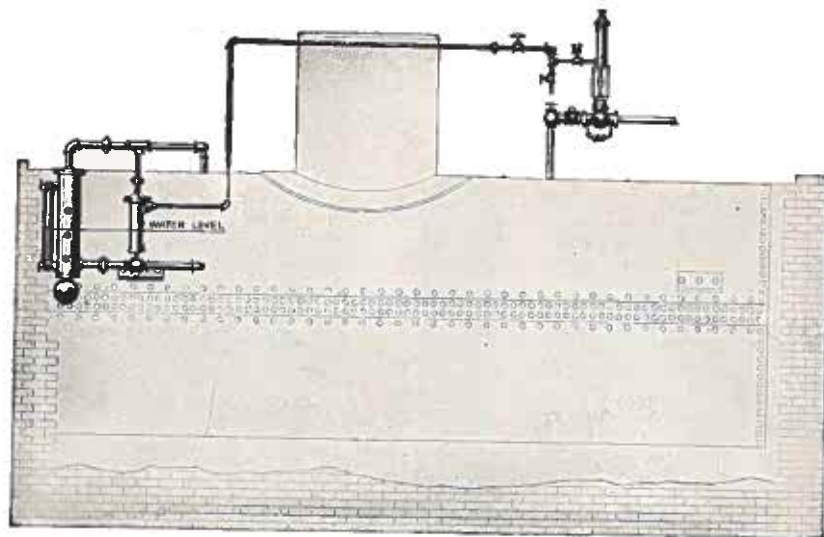

Wright-Austin Automatic Boiler Feed Water Regulator Applied to a Return Tubular Boiler

Increased evaporation will raise the water level in the boiler and cause the regulator to reduce the feed on sudden pulls or peak loads, until sufficient water has evaporated to lower the water level, when the Regulator will again open and feed the boiler.

If overload continues, the increased evaporation naturally lowers the water level, causing the control valve to be opened sufficiently to care for the overload but no more. With decreased loads the action is reversed, and the water level raised. Consequently, every load on the boiler has some corresponding water level which a Wright-Austin Regulator invariably maintains.

On the other hand, if a load suddenly drops off, the water level naturally recedes on account of the decreased evaporation. The Regulator immediately supplies water to the boiler, bringing the water level up to normal and absorbing the extra furnace heat, as well as preventing steam pressure building up and steam escaping through the safety valve.

The maximum load corresponds to the minimum permissible water level, and the minimum load to the maximum permissible water level.

The conditions just described make the Wright-Austin Regulator an especially valuable type, as compared with types of regulators which do not possess this flexibility, but which feed the boiler in exact proportion to the load at all times. The result is that a boiler equipped with the Wright-Austin Regulator has an exceptionally high overload capacity without priming, an exceptional adaptability to changes in load, and exceptional economy on sudden shifts from high to low load.

The regulator is unaffected by changes in temperature, either in the boiler room or outside, as there are no expansion elements or pressure apparatus to contend with.

Finally, the Wright-Austin Regulator has thirty five years of manufacturing and operating experience behind it; it is moderate in price and it is exceptionally well built.

**WRIGHT-AUSTIN AUTOMATIC BOILER FEED WATER
REGULATOR CONTROL VALVE**

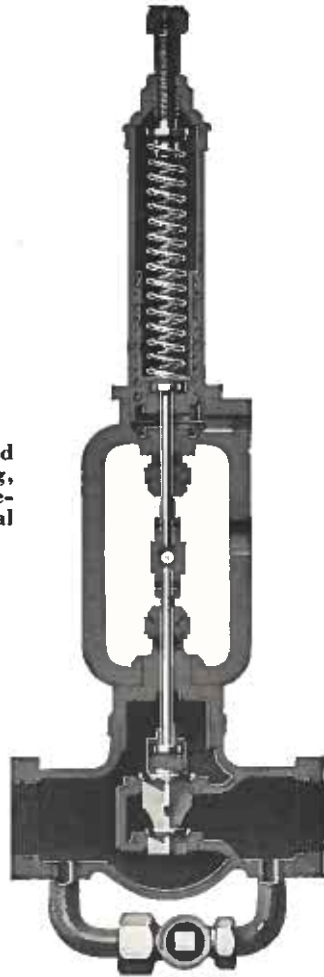

Shown with Screwed End Body, Type Bg, with By-Pass and Renewable Monel Metal Seats and Discs.

Construction of Wright-Austin Regulator Control Valve

This Valve, upon which actual regulation of feed water depends, is of first quality material and workmanship, and of very simple design. It can be readily dismantled, repaired and assembled without requiring readjustment. It is made of bronze, except for the Yoke, which is of cast iron. The Piston is water sealed; the Seat is of monel metal, or bronze, interchangeable and renewable; solid Seats can be furnished if desired. This Valve has been developed during a long term of years; all sources of trouble have been located and removed; thus the purchaser receives much more than an ordinary piece of equipment.

No pains have been spared to make this part of the Regulator simple, accurate, durable and reliable.

**TYPES OF CONTROL VALVE BODIES FOR
WRIGHT-AUSTIN REGULATORS**



TYPE A-Screwed Body Solid Seats



TYPE B-Screwed Body with Monel Metal Seats



TYPE C-Flanged Body Solid Seats

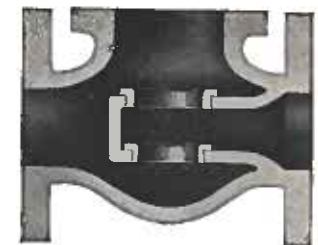

TYPE D-Flanged Body with Monel Metal Seats

Types similar to the above can also be furnished with a By-Pass (see illustration on preceding page). These are designated as Types Ag, Bg, Cg, and Dg, corresponding respectively to Types A, B, C and D shown above.

Control Valves can be furnished in any of the above types of Bodies. When writing for prices, specify the type of Body wanted, otherwise quotations will cover Body with By-Pass Attachments and Screwed Ends.

**PARTS FOR WRIGHT-AUSTIN AUTOMATIC
FEED WATER REGULATOR**

Tables

TABLE I

Expansion of Cast Iron, Steel and Brass Pipe
(Expansion from 0° F. in Inches per 100 Feet of Pipe)

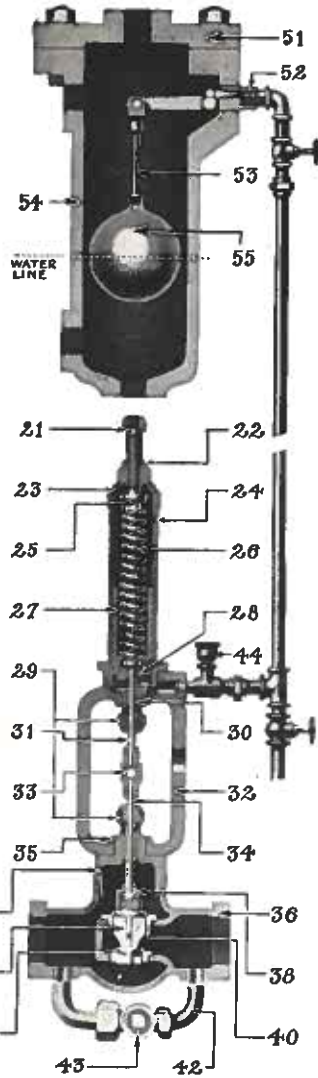

Parts of Regulator Column

- 51—Column Cover
- 52—Needle Valve and Lever
- 53—Float Rod and Clevis
- 54—Column Body
- 55—Float

When ordering parts, always specify **SIZE NUMBER** of Regulator Column cast on Body

Parts of Regulator Control Valve

- 21—Spring Bolt
- 22—Small Lock Nut
- 23—Cylinder Cap
- 24—Cylinder
- 25—Spring Center
- 26—Spring
- 27—Piston
- 28—Piston Nut
- 29—Packing Nut and Gland
- 30—Stuffing Box
- 31—Piston Stem
- 32—Yoke
- 33—Center Piece
- 34—Disc Stem
- 35—Large Lock Nut
- 36—Valve Body
- 37—Valve Top
- 38—Disc Nut
- 39—Disc
- 40—Large Removable Seat
- 41—Small Removable Seat
- 42—By-Pass Attachment Complete
- 43—By-Pass Valve
- 44—Oil Cup

When ordering parts, always specify **SIZE and TYPE** of Regulator Control Valve.

Pressure in Lbs. per Sq. In.	Temperature in Degrees F.	Cast Iron Inches	Steel Inches	Brass Inches
0	212	1.59	1.75	2.55
5	227	1.70	1.87	2.75
10	239	1.79	1.97	2.90
20	259	1.99	2.19	3.17
30	274	2.11	2.32	3.40
50	298	2.29	2.52	3.73
75	318	2.48	2.73	4.03
100	338	2.67	2.94	4.32
125	353	2.80	3.08	4.60
150	365	2.89	3.12	4.80
175	378	3.00	3.30	5.00
200	389	3.08	3.33	5.20
225	397	3.20	3.50	5.35
250	406	3.30	3.65	5.45
275	414	3.38	3.75	5.60
300	422	3.47	3.87	5.73
...	450	3.89	4.08	6.18
...	475	4.20	4.41	6.68
...	500	4.45	4.67	7.06
...	525	4.75	4.99	7.55
...	550	5.05	5.30	8.03
...	575	5.36	5.63	8.52
...	600	5.70	5.98	9.06
...	625	6.05	6.35	9.62
...	650	6.40	6.71	10.18
...	675	6.78	7.12	10.78
...	700	7.15	7.50	11.37

From Standard Authorities—Not Guaranteed

CODE WORDS FOR PRESSURES

Pressure in Lbs.	Code	Pressure in Lbs.	Code
100.....	Plumb	275.....	Plimp
125.....	Poker	300.....	Plots
150.....	Plane	350.....	Phram
175.....	Pivot	400.....	Phlit
200.....	Prime	450.....	Phads
225.....	Power	500.....	Photo
250.....	Punch	600.....	Phirn

TABLE II

Properties of Saturated Steam

From 29.0" Vacuum to Atmospheric Pressure

(Reprinted from "Steam Tables For Condenser Work" by courtesy of the Wheeler Condenser and Engineering Co.)

Vacuum in In. of Hg. referred to a 30" Bar. (Hg. at 58.4° F.)	Absolute Pressure in In. of Hg. at 32° F.	Absolute Pressure in Lb. per Sq. In.	Temperature Fahrenheit	Specific Volume Cu. Ft. per Lb.	Heat of the Liquid	Total Heat of Steam	Entropy of Water	Entropy of Steam
29.0	0.997	0.488	79.07	657.0	47.11	1094.3	0.0913	2.0358
28.5	1.495	0.732	91.70	446.2	59.70	1100.0	0.1146	2.0015
28.0	1.994	0.977	101.15	339.6	69.12	1104.1	0.1316	1.9772
27.5	2.493	1.221	108.70	275.2	76.64	1107.4	0.1449	1.9585
27.0	2.991	1.465	115.06	231.9	82.98	1110.2	0.1560	1.9434
26.5	3.490	1.710	120.55	200.2	88.46	1112.6	0.1654	1.9306
26.0	3.989	1.954	125.38	176.7	93.28	1114.7	0.1736	1.9197
25.5	4.487	2.198	129.75	158.1	97.64	1116.5	0.1812	1.9100
25.0	4.98	2.44	133.77	143.0	101.65	1118.3	0.1879	1.9013
24.0	5.98	2.93	140.64	129.0	108.51	1121.3	0.1994	1.8867
23.0	6.98	3.42	146.78	104.5	114.64	1123.9	0.2096	1.8739
22.0	7.97	3.90	152.16	92.3	120.02	1126.2	0.2185	1.8631
21.0	8.97	4.39	157.00	82.6	124.86	1128.2	0.2263	1.8535
20.0	9.97	4.88	161.42	74.8	129.28	1130.1	0.2334	1.8449
19.0	10.97	5.37	165.42	68.5	133.28	1131.8	0.2398	1.8372
18.0	11.96	5.86	169.14	63.1	137.00	1133.4	0.2457	1.8302
17.0	12.96	6.35	172.63	58.6	140.50	1134.8	0.2512	1.8238
16.0	13.96	6.84	175.93	54.6	143.80	1136.1	0.2564	1.8177
15.0	14.95	7.32	179.03	51.17	146.91	1137.4	0.2612	1.8121
14.0	15.95	7.81	181.92	49.03	149.80	1138.6	0.2658	1.8070
13.0	16.95	8.30	184.68	45.55	152.57	1139.7	0.2701	1.8021
12.0	17.95	8.79	187.31	43.18	155.21	1140.7	0.2742	1.7975
11.0	18.94	9.28	189.83	41.05	157.73	1141.7	0.2780	1.7932
10.0	19.94	9.77	192.23	39.13	160.14	1142.3	0.2817	1.7890
9.0	20.94	10.26	194.52	37.40	162.44	1143.6	0.2853	1.7852
8.0	21.94	10.75	196.73	35.79	164.68	1144.5	0.2887	1.7815
7.0	22.93	11.23	198.87	34.33	166.81	1145.4	0.2919	1.7779
6.0	23.93	11.72	200.94	33.00	168.88	1146.3	0.2951	1.7745
5.0	24.93	12.21	202.92	31.76	170.89	1147.0	0.2981	1.7712
4.0	25.92	12.70	204.85	30.62	172.81	1147.6	0.3010	1.7680
3.0	26.92	13.19	206.71	29.55	174.68	1148.4	0.3038	1.7650
2.0	27.92	13.68	208.52	28.57	176.50	1149.1	0.3065	1.7621
1.0	28.92	14.17	210.28	27.66	178.27	1149.7	0.3092	1.7593
0.0	29.92	14.67	212.00	26.79	180.00	1150.4	0.3118	1.7565

From Standard Authorities—Not Guaranteed

TABLE III

Properties of Saturated Steam

(Condensed by Kent from Marks and Davis' Steam Tables.)

Gage Pressure Pounds per Square Inch	Absolute Pressure Pounds per Square Inch	Temperature Fahrenheit	Total Heat above 32° F.		Latent Heat L = H - h Heat-units	Volume, Cubic Feet in 1 Pound of Steam	Weight of 1 Cubic Foot Steam, Pound	Entropy of the Water	Entropy of Evaporation
			In the Water Heat-units	In the Steam H, Heat-units					
0.0	14.70	212.0	180.0	1150.4	970.4	26.79	0.03732	0.3118	1.4447
0.3	15	213.0	181.0	1150.7	969.7	26.27	0.03806	0.3133	1.4416
1.3	16	216.3	184.4	1152.0	967.6	24.79	0.04042	0.3183	1.4311
2.3	17	219.4	187.5	1153.1	965.6	23.38	0.04277	0.3229	1.4215
3.3	18	222.4	190.5	1154.2	963.7	22.16	0.04512	0.3273	1.4127
4.3	19	225.2	193.4	1155.2	961.8	21.07	0.04746	0.3315	1.4045
5.3	20	228.0	196.1	1156.2	960.0	20.08	0.04980	0.3355	1.3965
6.3	21	230.6	198.8	1157.1	958.3	19.18	0.05213	0.3393	1.3887
7.3	22	233.1	201.3	1158.0	956.7	18.37	0.05445	0.3430	1.3811
8.3	23	235.5	203.8	1158.8	955.1	17.62	0.05676	0.3465	1.3739
9.3	24	237.8	206.1	1159.6	953.5	16.93	0.05907	0.3499	1.3670
10.3	25	240.1	208.4	1160.4	952.0	16.30	0.0614	0.3532	1.3604
11.3	26	242.2	210.6	1161.2	950.6	15.72	0.0636	0.3564	1.3542
12.3	27	244.4	212.7	1161.9	949.2	15.18	0.0659	0.3594	1.3483
13.3	28	246.4	214.8	1162.6	947.8	14.67	0.0682	0.3623	1.3425
14.3	29	248.4	216.8	1163.2	946.4	14.19	0.0705	0.3652	1.3367
15.3	30	250.3	218.8	1163.9	945.1	13.74	0.0728	0.3680	1.3311
16.3	31	252.2	220.7	1164.5	943.8	13.32	0.0751	0.3707	1.3257
17.3	32	254.1	222.6	1165.1	942.5	12.93	0.0773	0.3733	1.3205
18.3	33	255.8	224.4	1165.7	941.3	12.57	0.0795	0.3759	1.3155
19.3	34	257.6	226.2	1166.3	940.1	12.22	0.0818	0.3784	1.3107
20.3	35	259.3	227.9	1166.8	938.9	11.89	0.0841	0.3808	1.3060
30.3	45	274.5	243.4	1171.6	928.2	9.39	0.1065	0.4021	1.2644
40.3	55	287.1	256.3	1175.4	919.0	7.78	0.1285	0.4196	1.2309
50.3	65	298.0	267.5	1178.5	911.0	6.65	0.1503	0.4344	1.2024
60.3	75	307.6	277.4	1181.1	903.7	5.81	0.1721	0.4474	1.1778
70.3	85	316.3	286.3	1183.4	897.1	5.16	0.1937	0.4590	1.1561
80.3	95	324.1	294.5	1185.4	890.9	4.65	0.2151	0.4694	1.1367
85.3	100	327.8	298.3	1186.3	888.0	4.429	0.2258	0.4743	1.1277
95.3	110	334.8	305.5	1188.0	882.5	4.047	0.2472	0.4834	1.1108
105.3	120	341.3	312.3	1189.6	877.2	3.726	0.2683	0.4919	1.0954
115.3	130	347.4	318.6	1191.0	872.3	3.452	0.2897	0.4998	1.0809
125.3	140	353.1	324.6	1192.2	867.6	3.219	0.3107	0.5072	1.0675
135.3	150	358.5	330.2	1193.4	863.2	3.012	0.3320	0.5142	1.0550
145.3	160	363.6	335.6	1194.5	858.8	2.834	0.3529	0.5208	1.0431
155.3	170	368.5	340.7	1195.4	854.7	2.675	0.3738	0.5269	1.0321
165.3	180	373.1	345.6	1196.4	850.8	2.533	0.3948	0.5328	1.0215
175.3	190	377.6	350.4	1197.3	846.9	2.406	0.4157	0.5384	1.0114
185.3	200	381.9	354.9	1198.1	843.2	2.290	0.437	0.5437	1.0019
210.3	225	391.9	365.5	1199.9	834.4	2.046	0.489	0.5562	0.9799
235.3	250	401.1	375.2	1201.5	826.3	1.850	0.541	0.5676	0.9600
260.3	275	409.6	384.3	1203.0	818.6	1.688	0.593	0.5780	0.9420
285.3	300	417.5	392.7	1204.1	811.3	1.551	0.645	0.5878	0.9251

From Standard Authorities—Not Guaranteed

TABLE OF CONTENTS

	Page
General Description of Wright-Austin Line of Separators.....	5
Information Needed for Quotations.....	11
Vertical Steam Separators.....	12
Horizontal Steam Separators.....	16
Angle Steam Separators.....	21
"Standard Special" Steel Receiver Steam Separators.....	26
Oil Separators.....	32
"Standard Special" Steel Receiver Oil Separators.....	40
Compressed Air and Gas Separators.....	42
Companion Flanges.....	44
Exhaust Heads.....	46
"Airxpel" Bucket Type Steam Trap.....	53
Notes on Installation of "Airxpel" Steam Trap.....	62
"Emergency" High Pressure Steam Traps.....	70
Traps for Compressed Air.....	77
"Victor" Low Pressure Steam Traps.....	78
Notes on Installation of "Emergency" and "Victor" Steam Traps.....	83
Automatic Air Trap.....	84
Thermostatic Air Valve.....	85
Strainers.....	86
Tables—Dimensions of Pipe, Condensation in Steam Lines, etc.....	87
General Description of Wright-Austin Alarm Water Columns.....	93
Prices and Dimensions of Water Columns.....	98
Standard Special Columns for Large Boilers.....	100
"Brownie" Boiler Signal.....	104
Monel Metal Whistle Valve.....	105
Water Gauges and Trycocks.....	106
"Kleervu" Gauge Glass Protector.....	112
Automatic Pump Governor.....	117
Automatic Boiler Feed Water Regulator.....	118
Tables Expansion of Pipe and Properties of Steam.....	125

Page Numbers above refer to General Catalog Pages

Printed in U. S. A.